

GTX

GTX Table, GTX Desk

Tables & Desks

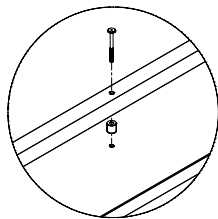
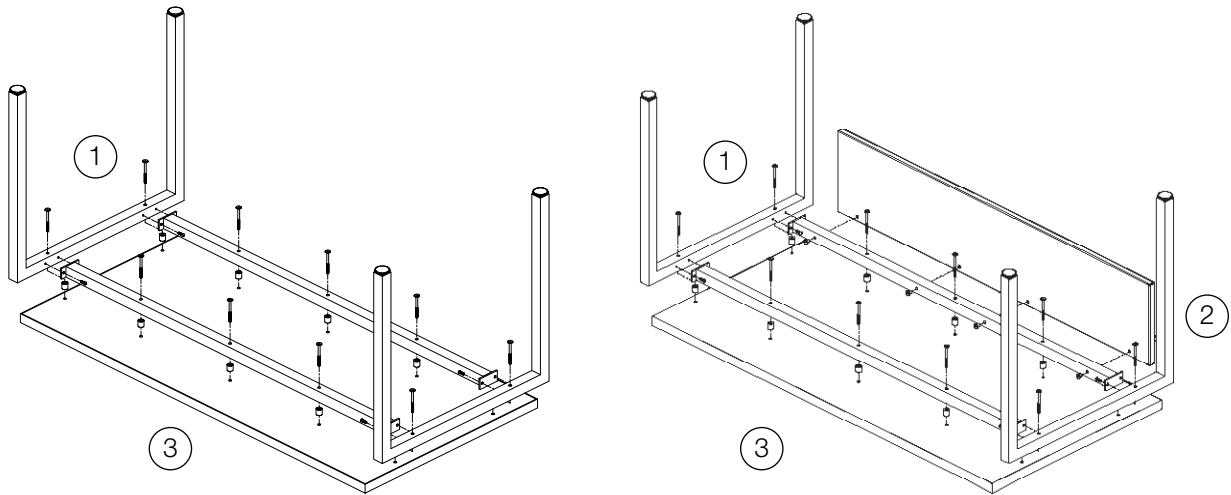

Spanner

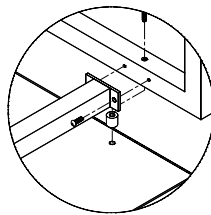

Spacers

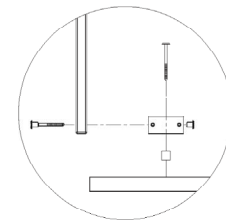

Modesty Panel
(For Desk Only)

Hardware Included:

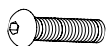

1/4-20 x 3/4"
Button Head Bolt



3/4" spacers

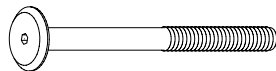

1/4-20 x 80 mm Bolt

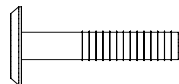

1/4-20 x 50 mm
Bolt



1/4-20 Nut (for desk only)

Tools Required:

- 5/32" Allen Wrench

Step 1:

Assemble leg frame to spanner by aligning hole in tab plate on end of the spanner with the threaded holes in leg frame as shown. Secure with 1/4-20 x 3/4" BH Bolt. If assembling GTX Table skip to Step 3.

Step 2:

For Desk Only: Attach modesty panel to insides of leg frames using 1/4-20 X 50mm Bolts and 1/4-20 nuts.

Step 3:

Attach base frame assembly to top of the table by placing the table top upside down on a clean, padded surface. Align holes in base frame assembly with inserts in underside of table top and place the 3/4" spacers in between. Attach base thru spacers with 1/4-20 x 80mm Bolts. Install Levelers.

Verify all bolts/screws are tightened.

instructions-gtx-191223

