



mediatechnologies®

Lot #7 Library & Lounge Furniture Catalog

New Jersey Schools Development Authority
Furniture, Fixtures & Equipment Contract

Contract No.: GP-0278-F11
Awarded to: mediatechnologies



Kelby Hirr

Northeast Regional Sales Manager

khirr@mediatechnologies.com

231-655-0553

mediatechnologies

www.mediatechnologies.com

sales@mediatechnologies.com

Required Item: Reading/Studying Tables and Chairs

Proposed Line: Bookmark Tables



B4242T-A-30

Required Item: Reading/Studying Tables and Chairs

Additional Line: Charleston Tables



CL0042T

Bookmark Tables

Key Features

- High Pressure Laminate work surface with phenolic backer.
- Hardwood Legs, Apron and Banding.
- For finishes refer to Mediatechnologies: Standard Finishes on Oak, Standard Finishes on Maple, Sprayon Finishes
- For work surface laminate refer to Mediatechnologies: General Laminates
- All tables meet BIFMA standards

Charleston Tables

Key Features

- High Pressure Laminate work surface with phenolic backer.
- Hardwood Legs with Charleston detail, Apron and Banding.
- For finishes refer to Mediatechnologies: Standard Finishes on Oak, Standard Finishes on Maple, Sprayon Finishes
- For work surface laminate refer to Mediatechnologies: General Laminates
- All tables meet BIFMA standards

1

Bookmark Library Tables

Rectangle	Model Number	Description	Wt.
	B2436T	24"W X 36"L Table	54
	B2436T-A	24"W X 36"L Table with apron	61
	B3060T	30"W X 60"L Table	86
	B3060T-A	30"W X 60"L Table with apron	96
	B3072T	30"W X 72"L Table	98
	B3072T-A	30"W X 72"L Table with apron	110
	B3660T	36"W X 60"L Table	98
	B3660T-A	36"W X 60"L Table with apron	110
	B4260T	42"W X 60"L Table	111
	B4260T-A	42"W X 60"L Table with apron	123
	B4860T	48"W X 60"L Table	123
	B4860T-A	48"W X 60"L Table with apron	136
	B3672T	36"W X 72"L Table	113
	B3672T-A	36"W X 72"L Table with apron	126
	B4272T	42"W X 72"L Table	128
	B4272T-A	42"W X 72"L Table with apron	142
	B4872T	48"W X 72"L Table	143
	B4872T-A	48"W X 72"L Table with apron	157
B3690T	36"W X 90"L Table	136	
B3690T-A	36"W X 90"L Table with apron	151	
B4290T	42"W X 90"L Table	155	
B4290T-A	42"W X 90"L Table with apron	170	
B4890T	48"W X 90"L Table	173	
B4890T-A	48"W X 90"L Table with apron	190	

Square	Model Number	Description	Wt.
	B4242T	42"W X 42"L Table	85
	B4242T-A	42"W X 42"L Table with apron	95
	B4848T	48"W X 48"L Table	103
	B4848T-A	48"W X 48"L Table with apron	115

Round	Model Number	Description	Wt.
	B0042T	42" Diameter Table	76
	B0042T-A	42" Diameter Table with apron	83
	B0048T	48" Diameter Table	92
	B0048T-A	48" Diameter Table with apron	102

Charleston Library Tables

Rectangle	Model Number	Description	Wt.
	CL3060T	30"W X 60"L Charleston Table	96
	CL3660T	36"W X 60"L Charleston Table	110
	CL4260T	42"W X 60"L Charleston Table	125
	CL3672T	36"W X 72"L Charleston Table	128
	CL4272T	42"W X 72"L Charleston Table	145

Square	Model Number	Description	Wt.
	CL4242T	42"W X 42"L Charleston Table	96
	CL4848T	48"W X 48"L Charleston Table	116

Round	Model Number	Description	Wt.
	CL0042T	42" Diameter Charleston Table	85
	CL0048T	48" Diameter Charleston Table	105

Panel End Tables	Model Number	Description	Wt.
	CLP3060T	30"W X 60"L Charleston Panel Table	128
	CLP3660T	36"W X 60"L Charleston Panel Table	151
	CLP4260T	42"W X 60"L Charleston Panel Table	174
	CLP4860T	48"W X 60"L Charleston Panel Table	200
	CLP3672T	36"W X 72"L Charleston Panel Table	166
	CLP4272T	42"W X 72"L Charleston Panel Table	199
	CLP4872T	48"W X 72"L Charleston Panel Table	221
	CLP3690T	36"W X 90"L Charleston Panel Table	193
	CLP4290T	42"W X 90"L Charleston Panel Table	228
	CLP4890T	48"W X 90"L Charleston Panel Table	254



Required Item: Reading/Studying Tables and Chairs

Additional Line: Heritage Tables



Heritage H3060T

Required Item: Reading/Studying Tables and Chairs

Additional Line: Lexington Tables



Lexington L0048T

Heritage Tables

Key Features

- High Pressure Laminate work surface with phenolic backer.
- Hardwood Legs with Charleston detail, Apron and Banding.
- For finishes refer to Mediatechnologies: Standard Finishes on Oak, Standard Finishes on Maple
- For work surface laminate refer to Mediatechnologies: General Laminates
- All tables meet BIFMA standards

Lexington Tables

Key Features

- High Pressure Laminate work surface with phenolic backer.
- Hardwood Legs with Lexington detail, Apron and Banding.
- For finishes refer to Mediatechnologies: Standard Finishes on Oak, Standard Finishes on Maple, Sprayon Finishes
- For work surface laminate refer to Mediatechnologies: General Laminates
- All tables meet BIFMA standards

Heritage Library Tables

Rectangle	Model Number	Description	Wt.
	H2436T	24"W X 36"L Heritage Table	64
	H2436T-A	24"W X 36"L Heritage Table with Apron	71
	H3060T	30"W X 60"L Heritage Table	96
	H3060T-A	30"W X 60"L Heritage Table with Apron	109
	H3660T	36"W X 60"L Heritage Table	110
	H3660T-A	36"W X 60"L Heritage Table with Apron	124
	H4260T	42"W X 60"L Heritage Table	125
	H4260T-A	42"W X 60"L Heritage Table with Apron	135
	H3672T	36"W X 72"L Heritage Table	128
	H3672T-A	36"W X 72"L Heritage Table with Apron	138
	H4272T	42"W X 72"L Heritage Table	145
	H4272T-A	42"W X 72"L Heritage Table with Apron	156

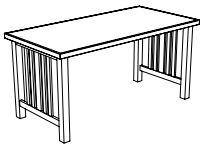

Square	Model Number	Description	Wt.
	H4242T	42"W X 42"L Heritage Table	96
	H4242T-A	42"W X 42"L Heritage Table with Apron	104
	H4848T	48"W X 48"L Heritage Table	116
	H4848T-A	48"W X 48"L Heritage Table with Apron	125

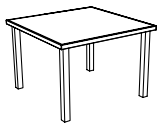

Round	Model Number	Description	Wt.
	H0042T	42" Diameter Heritage Table	85
	H0042T-A	42" Diameter Heritage Table with Apron	92
	H0048T	48" Diameter Heritage Table	105
	H0048T-A	48" Diameter Heritage Table with Apron	113



Panel End Tables	Model Number	Description	Wt.
	HP3060T	30"W X 60"L Heritage Panel Table	128
	HP3660T	36"W X 60"L Heritage Panel Table	151
	HP4260T	42"W X 60"L Heritage Panel Table	174
	HP4860T	48"W X 60"L Heritage Panel Table	200
	HP3672T	36"W X 72"L Heritage Panel Table	166
	HP4272T	42"W X 72"L Heritage Panel Table	199
	HP4872T	48"W X 72"L Heritage Panel Table	221
	HP3690T	36"W X 90"L Heritage Panel Table	193
	HP4290T	42"W X 90"L Heritage Panel Table	228
	HP4890T	48"W X 90"L Heritage Panel Table	254

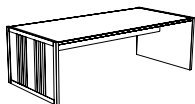

Lexington Library Tables

Rectangle	Model Number	Description	Wt.
	L3060T	30"W X 60"L Lexington Table	96
	L3660T	36"W X 60"L Lexington Table	110
	L4260T	42"W X 60"L Lexington Table	125
	L3672T	36"W X 72"L Lexington Table	128
	L4272T	42"W X 72"L Lexington Table	145

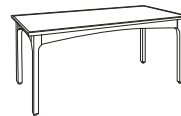

Square	Model Number	Description	Wt.
	L4242T	42"W X 42"L Lexington Table	96
	L4848T	48"W X 48"L Lexington Table	116



Round	Model Number	Description	Wt.
	L0042T	42" Diameter Lexington Table	85
	L0048T	48" Diameter Lexington Table	105

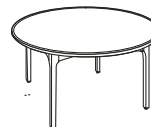

Panel End Tables	Model Number	Description	Wt.
	LP3060T	30"W X 60"L Lexington Panel Table	128
	LP3660T	36"W X 60"L Lexington Panel Table	151
	LP4260T	42"W X 60"L Lexington Panel Table	174
	LP4860T	48"W X 60"L Lexington Panel Table	200
	LP3672T	36"W X 72"L Lexington Panel Table	166
	LP4272T	42"W X 72"L Lexington Panel Table	199
	LP4872T	48"W X 72"L Lexington Panel Table	221
	LP3690T	36"W X 90"L Lexington Panel Table	193
	LP4290T	42"W X 90"L Lexington Panel Table	228
	LP4890T	48"W X 90"L Lexington Panel Table	254

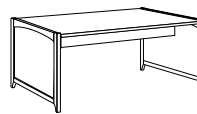

Required Item: Reading/Studying Tables and Chairs

Additional Line: Metro Tables



Metro M3672T

Required Item: Reading/Studying Tables and Chairs

Additional Line: Malibu Tables



Malibu MB4242T

Metro Tables

Key Features

- High Pressure Laminate work surface with phenolic backer.
- Hardwood Legs with Metro detail, Apron and Banding.
- For finishes refer to Mediatechnologies: Standard Finishes on Oak, Standard Finishes on Maple, Sprayon Finishes
- For work surface laminate refer to Mediatechnologies: General Laminates
- All tables meet BIFMA standards

Malibu Tables

Key Features

- High Pressure Laminate work surface with phenolic backer.
- Hardwood Legs with Malibu detail, Apron and Banding.
- For finishes refer to Mediatechnologies: Standard Finishes on Oak, Standard Finishes on Maple, Sprayon Finishes
- For work surface laminate refer to Mediatechnologies: General Laminates
- All tables meet BIFMA standards

Metro Library Tables

Rectangle	Model Number	Description	Wt.
	M3060T	30"W X 60"L Metro Table	96
	M3660T	36"W X 60"L Metro Table	110
	M4260T	42"W X 60"L Metro Table	123
	M4860T	48"W X 60"L Metro Table	137
	M3672T	36"W X 72"L Metro Table	126
	M4272T	42"W X 72"L Metro Table	143
	M4872T	48"W X 72"L Metro Table	157
	M3690T	36"W X 90"L Metro Table	153
	M4290T	42"W X 90"L Metro Table	170
	M4890T	48"W X 90"L Metro Table	190

Square	Model Number	Description	Wt.
	M4242T	42"W X 42"L Metro Table	95
	M4848T	48"W X 48"L Metro Table	115

Round	Model Number	Description	Wt.
	M0042T	42" Diameter Metro Table	83
	M0048T	48" Diameter Metro Table	102

Malibu Library Tables

Rectangle	Model Number	Description	Wt.
	MB3060T	30"W X 60"L Malibu Table	96
	MB3660T	36"W X 60"L Malibu Table	110
	MB4260T	42"W X 60"L Malibu Table	125
	MB3672T	36"W X 72"L Malibu Table	128
	MB4272T	42"W X 72"L Malibu Table	145

Square	Model Number	Description	Wt.
	MB4242T	42"W X 42"L Malibu Table	96
	MB4848T	48"W X 48"L Malibu Table	116

Round	Model Number	Description	Wt.
	MB0042T	42" Diameter Malibu Table	85
	MB0048T	48" Diameter Malibu Table	105



Required Item: Reading/Studying Tables and Chairs

Additional Line: Rockford Tables



Rockford RF-3060WR



Rockford Tables

Key Features

- High Pressure Laminate work surface with phenolic backer and PVC banding
- Fixed Height and Height adjustable powder coated steel legs
- Casters available (Casters add 2" height)
- For powder coats refer to Mediatechnologies: Powder Coat Colors
- For work surface laminate refer to Mediatechnologies: General Laminates
- For Edgeband refer to Mediatechnologies: Standard PVC Selections
- All tables meet BIFMA standards

4

Rectangular Tables		
Model Number	Description	Wt.
Adjustable Height		
RF-C2436	24"D x 36"W	54
RF-C2442	24"D x 42"W	59
RF-C2448	24"D x 48"W	64
RF-C2460	24"D x 60"W	79
RF-C2472	24"D x 72"W	87
RF-C3036	30"D x 36"W	60
RF-C3042	30"D x 42"W	68
RF-C3048	30"D x 48"W	76
RF-C3060	30"D x 60"W	92
RF-C3072	30"D x 72"W	103
25" Height		
RF-C2436-25	24"D x 36"W x 25" H	54
RF-C2442-25	24"D x 42"W x 25" H	59
RF-C2448-25	24"D x 48"W x 25" H	64
RF-C2460-25	24"D x 60"W x 25" H	79
RF-C2472-25	24"D x 72"W x 25" H	87
RF-C3036-25	30"D x 36"W x 25" H	60
RF-C3042-25	30"D x 42"W x 25" H	68
RF-C3048-25	30"D x 48"W x 25" H	76
RF-C3060-25	30"D x 60"W x 25" H	92
RF-C3072-25	30"D x 72"W x 25" H	103
27" Height		
RF-C2436-27	24"D x 36"W x 27" H	54
RF-C2442-27	24"D x 42"W x 27" H	59
RF-C2448-27	24"D x 48"W x 27" H	64
RF-C2460-27	24"D x 60"W x 27" H	79
RF-C2472-27	24"D x 72"W x 27" H	87
RF-C3036-27	30"D x 36"W x 27" H	60
RF-C3042-27	30"D x 42"W x 27" H	68
RF-C3048-27	30"D x 48"W x 27" H	76
RF-C3060-27	30"D x 60"W x 27" H	92
RF-C3072-27	30"D x 72"W x 27" H	103

29" Height		
Model Number	Description	Wt.
RF-C2436-29	24"D x 36"W x 29" H	54
RF-C2442-29	24"D x 42"W x 29" H	59
RF-C2448-29	24"D x 48"W x 29" H	64
RF-C2460-29	24"D x 60"W x 29" H	79
RF-C2472-29	24"D x 72"W x 29" H	87
RF-C3036-29	30"D x 36"W x 29" H	60
RF-C3042-29	30"D x 42"W x 29" H	68
RF-C3048-29	30"D x 48"W x 29" H	76
RF-C3060-29	30"D x 60"W x 29" H	92
RF-C3072-29	30"D x 72"W x 29" H	103

Round Tables		
Model Number	Description	Wt.
Adjustable Height		
RF-C0042	42" Dia.	70
RF-C0048	48" Dia.	86
RF-C0060	60" Dia.	124
25" Height		
RF-C0042-25	42" Dia. x 25" H	70
RF-C0048-25	48" Dia. x 25" H	86
RF-C0060-25	60" Dia. x 25" H	124
27" Height		
RF-C0042-27	42" Dia. x 27" H	70
RF-C0048-27	48" Dia. x 27" H	86
RF-C0060-27	60" Dia. x 27" H	124
29" Height		
RF-C0042-29	42" Dia. x 29" H	70
RF-C0048-29	48" Dia. x 29" H	86
RF-C0060-29	60" Dia. x 29" H	124



Round
RF-C0048
Diameters: 42", 48", 60"



Squircle
RF-C4242
Depths: 36", 42", 48", 54" 60"
Width: 36", 42", 48", 54" 60"



Quarter Round
RF-C36QR
Diameter: 24/36"



Rectangle
RF-C2460
Depths: 24", 30"
Widths: 36", 42", 48", 60", 72"



Square
RF-C4242
Depths: 42", 48", 60"
Width: 42", 48", 60"



Trapezoid
RF-C30TRP
Depth: 30"
Width: 30"



Pickle
RF-C3660G
Depth: 36"
Width: 60"



Rockford Crescent Tables and Hannah Chairs

Square Tables

Model Number	Description	Wt.
Adjustable Height		
RF-C4242	42"D x 42"W	88
RF-C4848	48"D x 48"W	108
RF-C6060	60"D x 60"W	159
25" Height		
RF-C4242-25	42"D x 42"W x 25" H	88
RF-C4848-25	48"D x 48"W x 25" H	108
RF-C6060-25	60"D x 60"W x 25" H	159
27" Height		
RF-C4242-27	42"D x 42"W x 27" H	88
RF-C4848-27	48"D x 48"W x 27" H	108
RF-C6060-27	60"D x 60"W x 27" H	159
29" Height		
RF-C4242-29	42"D x 42"W x 29" H	88
RF-C4848-29	48"D x 48"W x 29" H	108
RF-C6060-29	60"D x 60"W x 29" H	159

Squircle

Model Number	Description	Wt.
Adjustable Height		
RF-C3636SQR	36" x 36", 9" Radius corner	68
RF-C4242SQR	42" x 42", 10.5" Radius corner	88
RF-C4848SQR	48" x 48", 12" Radius corner	108
RF-C5454SQR	54" x 54", 13.5" Radius corner	146
RF-C6060SQR	60" x 60", 15" Radius corner	159
25" Height		
RF-C3636SQR-25	36" x 36" x 25"H, 9" Radius corner	68
RF-C4242SQR-25	42" x 42" x 25"H, 10.5" Radius corner	88
RF-C4848SQR-25	48" x 48" x 25"H, 12" Radius corner	108
RF-C5454SQR-25	54" x 54" x 25"H, 13.5" Radius corner	146
RF-C6060SQR-25	60" x 60" x 25"H, 15" Radius corner	159

27" Height		
RF-C3636SQR-27	36" x 36" x 27"H, 9" Radius corner	68
RF-C4242SQR-27	42" x 42" x 27"H, 10.5" Radius corner	88
RF-C4848SQR-27	48" x 48" x 27"H, 12" Radius corner	108
RF-C5454SQR-27	54" x 54" x 27"H, 13.5" Radius corner	146
RF-C6060SQR-27	60" x 60" x 27"H, 15" Radius corner	159

29" Height		
RF-C3636SQR-29	36" x 36" x 29"H, 9" Radius corner	68
RF-C4242SQR-29	42" x 42" x 29"H, 10.5" Radius corner	88
RF-C4848SQR-29	48" x 48" x 29"H, 12" Radius corner	108
RF-C5454SQR-29	54" x 54" x 29"H, 13.5" Radius corner	146
RF-C6060SQR-29	60" x 60" x 29"H, 15" Radius corner	159

Quarter Round Tables

Model Number	Description	Wt.
RF-C36QR	24" / 36" Adj	58
RF-C36QR-25	24" / 36" x 25" H	58
RF-C36QR-27	24" / 36" x 27" H	58
RF-C36QR-29	24" / 36" x 29" H	58

Trapezoid Tables

Model Number	Description	Wt.
RF-C30TRP	30" x 30" x 30" x 60" Adj	98
RF-C30TRP-25	30" x 30" x 30" x 60" x 25" H	98
RF-C30TRP-27	30" x 30" x 30" x 60" x 27" H	98
RF-C30TRP-29	30" x 30" x 30" x 60" x 29" H	98

Pickle Tables

Model Number	Description	Wt.
RF-C3660G	36", x 60" Adj	103
RF-C3660G-25	36", x 60" x 25" H	103
RF-C3660G-27	36", x 60" x 27" H	103
RF-C3660G-29	36", x 60" x 29" H	103

Required Item: Reading/Studying Tables and Chairs

Additional Line: Rockford Tables

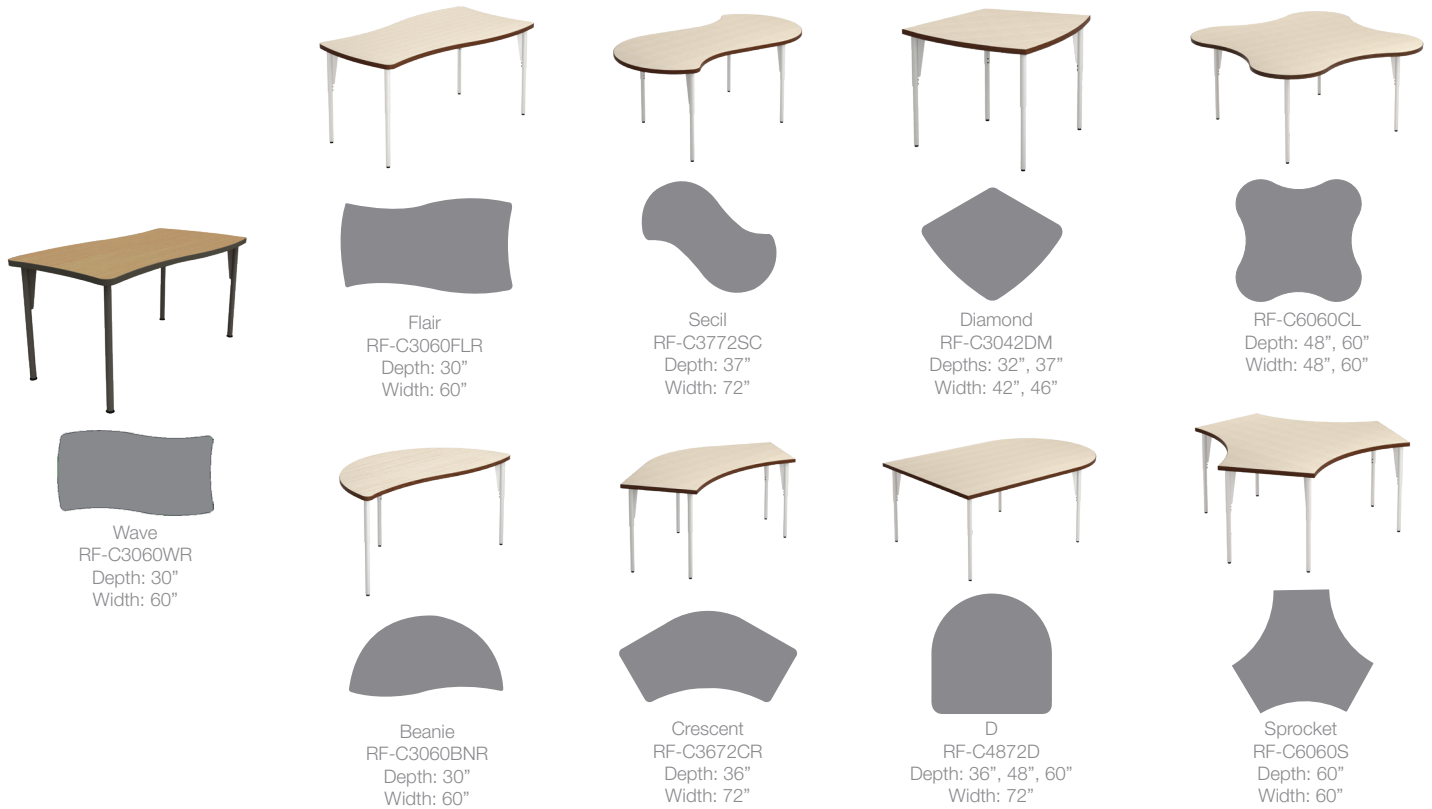

6

Beanie Tables

Model Number	Description	Wt.
RF-C3060BNR	29.25", x 58.375" Adj	103
RF-C3060BNR-25	29.25", x 58.375" x 25" H	103
RF-C3060BNR-27	29.25", x 58.375" x 27" H	103
RF-C3060BNR-29	29.25", x 58.375" x 29" H	103

Flair Tables

Model Number	Description	Wt.
RF-C3060FLR	32.25", x 59.5" Adj	103
RF-C3060FLR-25	32.25", x 59.5" x 25" H	103
RF-C3060FLR-27	32.25", x 59.5" x 27" H	103
RF-C3060FLR-29	32.25", x 59.5" x 29" H	103

Wave Tables

Model Number	Description	Wt.
RF-C3060WR	32.5", x 59.5" Adj	103
RF-C3060WR-25	32.5", x 59.5" x 25" H	103
RF-C3060WR-27	32.5", x 59.5" x 27" H	103
RF-C3060WR-29	32.5", x 59.5" x 29" H	103

Raetsel

Model Number	Description	Wt.
RF-C4565RL	45", x 65" Adj	103
RF-C4565RL-25	45", x 65" x 25" H	103
RF-C4565RL-27	45", x 65" x 27" H	103
RF-C4565RL-29	45", x 65" x 29" H	103

Pick Tables

Model Number	Description	Wt.
RFP-C2728	27" x 28" Adj	32
RFP-C4042	40" x 42" Adj	40
RFP-C2728-25	27" x 28" x 25" H	32
RFP-C4042-25	40" x 42" x 25" H	40
RFP-C2728-27	27" x 28" x 27" H	32
RFP-C4042-27	40" x 42" x 27" H	40
RFP-C2728-29	27" x 28" x 29" H	32
RFP-C4042-29	40" x 42" x 29" H	40

"D" Shape Tables

Model Number	Description	Wt.
RF-C3672D	36" x 72" Adj	
RF-C4872D	48" x 72" Adj	98
RF-C6072D	60" x 72" Adj	
25" Height		
RF-C3672D-25	36" x 72" x 25" H	
RF-C4872D-25	48" x 72" x 25" H	98
RF-C6072D-25	60" x 72" x 25" H	
27" Height		
RF-C3672D-27	36", x 72" x 27" H	
RF-C4872D-27	48", x 72" x 27" H	98
RF-C6072D-27	60", x 72" x 27" H	
29" Height		
RF-C3672D-29	36", x 72" x 29" H	
RF-C4872D-29	48", x 72" x 29" H	98
RF-C6072D-29	60", x 72" x 29" H	

Sprocket Top Tables

Model Number	Description	Wt.
RF-C6060S	60"W x 60"D Adj	145
RF-C6060S-25	60"W x 60"D x 25" H	145
RF-C6060S-27	60"W x 60"D x 27" H	145
RF-C6060S-29	60"W x 60"D x 29" H	145

Secil Top Tables

Model Number	Description	Wt.
RF-C3772SC	37", W x 72"D Adj	103
RF-C3772SC-25	37", W x 72"D x 25" H	103
RF-C3772SC-27	37", W x 72"D x 27" H	103
RF-C3772SC-29	37", W x 72"D x 29" H	103



Rockford Raetsel Tables and Hannah Chairs

Diamond Top Tables		
Model Number	Description	Wt.
RF-C3242DM	32", D x 42"W Adj	68
RF-C3746DM	37", D X 46"W Adj	70
RF-C3242DM-25	32", D x 42"W x 25" H	68
RF-C3746DM-25	37", D X 46"W X 25"H	70
RF-C3242DM-27	32", D x 42"W x 27" H	68
RF-C3746DM-27	37", D X 46"W X 27"H	70
RF-C3242DM-29	32", D x 42"W x 29" H	68
RF-C3746DM-29	37", D X 46"W X 29"H	70

Crescent Top Tables		
Model Number	Description	Wt.
RF-C3672CR	36", W x 72"D Adj	103
RF-C3672CR-25	36", W x 72"D x 25" H	103
RF-C3672CR-27	36", W x 72"D x 27" H	103
RF-C3672CR-29	36", W x 72"D x 29" H	103

Clover Top Tables		
Model Number	Description	Wt.
RF-C4848CL	48"W x 48"D Adj	86
RF-C6060CL	60"W x 60"D Adj	159
RF-C4848CL-25	48"W x 48"D x 25" H	86
RF-C6060CL-25	60"W x 60"D x 25" H	159
RF-C4848CL-27	48"W x 48"D x 27" H	86
RF-C6060CL-27	60"W x 60"D x 27" H	159
RF-C4848CL-29	48"W x 48"D x 29" H	86
RF-C6060CL-29	60"W x 60"D x 29" H	159

Pacman Tables		
Model Number	Description	Wt.
25" Height		
RF-C0036PAC	36", Dia. Adj	55
RF-C0042PAC	42", Dia. Adj	70
RF-C0048PAC	48", Dia. Adj	86
25" Height		
RF-C0036PAC-25	36", Dia. x 25" H	55
RF-C0042PAC-25	42", Dia. x 25" H	70
RF-C0048PAC-25	48", Dia. x 25" H	86
27" Height		
RF-C0036PAC-27	36", Dia. x 27" H	55
RF-C0042PAC-27	42", Dia. x 27" H	70
RF-C0048PAC-27	48", Dia. x 27" H	86
29" Height		
RF-C0036PAC-29	36", Dia. x 29" H	55
RF-C0042PAC-29	42", Dia. x 29" H	70
RF-C0048PAC-29	48", Dia. x 29" H	86

Required Item: Reading/Studying Tables and Chairs

Additional Line: Cesar Tables



CX20-C0024-18



Cesar Tables

Key Features

- High Pressure Laminate work surface with phenolic backer and PVC banding
- Steel powder coated steel tube legs. Aluminum feet and 1" Diameter levelers.
- Available in 29", 36" and 42" Height. Flip-top available. Casters available
- For powder coats refer to Mediatechnologies: Powder Coat Colors
- For work surface laminate refer to Mediatechnologies: General Laminates
- For Edgeband refer to Mediatechnologies: Standard PVC Selections
- All tables meet BIFMA standards

Cesar Rectangular Tables

Model Number	Description
29"H, T-Base, Square Corners, PVC Edge	
CT20-C2436-29	Cesar Rectangle Table, 24"D x 36"L x 29"H
CT20-C2448-29	Cesar Rectangle Table, 24"D x 48"L x 29"H
CT20-C2460-29	Cesar Rectangle Table, 24"D x 60"L x 29"H
CT20-C2472-29	Cesar Rectangle Table, 24"D x 72"L x 29"H
CT26-C3048-29	Cesar Rectangle Table, 30"D x 48"L x 29"H
CT26-C3060-29	Cesar Rectangle Table, 30"D x 60"L x 29"H
CT26-C3072-29	Cesar Rectangle Table, 30"D x 72"L x 29"H
CT26-C3648-29	Cesar Rectangle Table, 36"D x 48"L x 29"H
CT26-C3660-29	Cesar Rectangle Table, 36"D x 60"L x 29"H
CT26-C3672-29	Cesar Rectangle Table, 36"D x 72"L x 29"H
29"H, VTT-Base, Square Corners, PVC Edge	
C2V28-C4260-29	Cesar Rectangle Table, 42"D x 60"L x 29"H
C2V28-C4272-29	Cesar Rectangle Table, 42"D x 72"L x 29"H
C2V28-C4284-29	Cesar Rectangle Table, 42"D x 84"L x 29"H
C2V32-C4860-29	Cesar Rectangle Table, 48"D x 60"L x 29"H
C2V32-C4872-29	Cesar Rectangle Table, 48"D x 72"L x 29"H
C2V32-C4884-29	Cesar Rectangle Table, 48"D x 84"L x 29"H
36"H, T-Base, Square Corners, PVC Edge	
CT20-C2436-36	Cesar Rectangle Table, 24"D x 36"L x 36"H
CT20-C2448-36	Cesar Rectangle Table, 24"D x 48"L x 36"H
CT20-C2460-36	Cesar Rectangle Table, 24"D x 60"L x 36"H
CT20-C2472-36	Cesar Rectangle Table, 24"D x 72"L x 36"H
CT26-C3048-36	Cesar Rectangle Table, 30"D x 48"L x 36"H
CT26-C3060-36	Cesar Rectangle Table, 30"D x 60"L x 36"H
CT26-C3072-36	Cesar Rectangle Table, 30"D x 72"L x 36"H
CT26-C3648-36	Cesar Rectangle Table, 36"D x 48"L x 36"H
CT26-C3660-36	Cesar Rectangle Table, 36"D x 60"L x 36"H
CT26-C3672-36	Cesar Rectangle Table, 36"D x 72"L x 36"H

36"H, VTT-Base, Square Corners, PVC Edge	
C2V28-C4260-36	Cesar Rectangle Table, 42"D x 60"L x 36"H
C2V28-C4272-36	Cesar Rectangle Table, 42"D x 72"L x 36"H
C2V28-C4284-36	Cesar Rectangle Table, 42"D x 84"L x 36"H
C2V32-C4860-36	Cesar Rectangle Table, 48"D x 60"L x 36"H
C2V32-C4872-36	Cesar Rectangle Table, 48"D x 72"L x 36"H
C2V32-C4884-36	Cesar Rectangle Table, 48"D x 84"L x 36"H
42"H, T-Base, Square Corners, PVC Edge	
CT20-C2436-42	Cesar Rectangle Table, 24"D x 36"L x 42"H
CT20-C2448-42	Cesar Rectangle Table, 24"D x 48"L x 42"H
CT20-C2460-42	Cesar Rectangle Table, 24"D x 60"L x 42"H
CT20-C2472-42	Cesar Rectangle Table, 24"D x 72"L x 42"H
CT26-C3048-42	Cesar Rectangle Table, 30"D x 48"L x 42"H
CT26-C3060-42	Cesar Rectangle Table, 30"D x 60"L x 42"H
CT26-C3072-42	Cesar Rectangle Table, 30"D x 72"L x 42"H
CT26-C3648-42	Cesar Rectangle Table, 36"D x 48"L x 42"H
CT26-C3660-42	Cesar Rectangle Table, 36"D x 60"L x 42"H
CT26-C3672-42	Cesar Rectangle Table, 36"D x 72"L x 42"H
42"H, VTT-Base, Square Corners, PVC Edge	
C2V28-C4260-42	Cesar Rectangle Table, 42"D x 60"L x 42"H
C2V28-C4272-42	Cesar Rectangle Table, 42"D x 72"L x 42"H
C2V28-C4284-42	Cesar Rectangle Table, 42"D x 84"L x 42"H
C2V32-C4860-42	Cesar Rectangle Table, 48"D x 60"L x 42"H
C2V32-C4872-42	Cesar Rectangle Table, 48"D x 72"L x 42"H
C2V32-C4884-42	Cesar Rectangle Table, 48"D x 84"L x 42"H



Rectangle
 Depths: 20", 24", 30", 36", 42", 48"
 Widths: 36", 48", 60", 72", 84"



Rectangle
 with VTT Base



Sprocket
 Depths: 60"
 Widths: 60"



Wave
 Depths: 30"
 Widths: 60"



Flair
 Depths: 30"
 Widths: 60"



Beanie
 Depths: 30"
 Widths: 60"



Round
 DIA: 24", 30", 36",
 42", 48", 60"



Square
 Depths: 24", 30", 36", 42", 48", 60"
 Widths: 24", 30", 36", 42", 48", 60"



Trap
 Depths: 30", 36"
 Widths: 60", 72"



Roundtable
 Sides: 42", 55"
 Returns: 24", 32"

Cesar Rectangular Tables with Radiused Corners

Model Number	Description
29"H, T-Base, Radiused Corners, PVC Edge	
CT20-C2436R-29	Cesar Rectangle Table, 24"D x 36"L x 29"H
CT20-C2448R-29	Cesar Rectangle Table, 24"D x 48"L x 29"H
CT20-C2460R-29	Cesar Rectangle Table, 24"D x 60"L x 29"H
CT20-C2472R-29	Cesar Rectangle Table, 24"D x 72"L x 29"H
CT26-C3048R-29	Cesar Rectangle Table, 30"D x 48"L x 29"H
CT26-C3060R-29	Cesar Rectangle Table, 30"D x 60"L x 29"H
CT26-C3072R-29	Cesar Rectangle Table, 30"D x 72"L x 29"H
CT26-C3648R-29	Cesar Rectangle Table, 36"D x 48"L x 29"H
CT26-C3660R-29	Cesar Rectangle Table, 36"D x 60"L x 29"H
CT26-C3672R-29	Cesar Rectangle Table, 36"D x 72"L x 29"H
29"H, VTT-Base, Radiused Corners, PVC Edge	
C2V28-C4260R-29	Cesar Rectangle Table, 42"D x 60"L x 29"H
C2V28-C4272R-29	Cesar Rectangle Table, 42"D x 72"L x 29"H
C2V28-C4284R-29	Cesar Rectangle Table, 42"D x 84"L x 29"H
C2V32-C4860R-29	Cesar Rectangle Table, 48"D x 60"L x 29"H
C2V32-C4872R-29	Cesar Rectangle Table, 48"D x 72"L x 29"H
C2V32-C4884R-29	Cesar Rectangle Table, 48"D x 84"L x 29"H
36"H, T-Base, Radiused Corners, PVC Edge	
CT20-C2436R-36	Cesar Rectangle Table, 24"D x 36"L x 36"H
CT20-C2448R-36	Cesar Rectangle Table, 24"D x 48"L x 36"H
CT20-C2460R-36	Cesar Rectangle Table, 24"D x 60"L x 36"H
CT20-C2472R-36	Cesar Rectangle Table, 24"D x 72"L x 36"H
CT26-C3048R-36	Cesar Rectangle Table, 30"D x 48"L x 36"H
CT26-C3060R-36	Cesar Rectangle Table, 30"D x 60"L x 36"H
CT26-C3072R-36	Cesar Rectangle Table, 30"D x 72"L x 36"H
CT26-C3648R-36	Cesar Rectangle Table, 36"D x 48"L x 36"H
CT26-C3660R-36	Cesar Rectangle Table, 36"D x 60"L x 36"H
CT26-C3672R-36	Cesar Rectangle Table, 36"D x 72"L x 36"H

36"H, VTT-Base, Radiused Corners, PVC Edge	
C2V28-C4260R-36	Cesar Rectangle Table, 42"D x 60"L x 36"H
C2V28-C4272R-36	Cesar Rectangle Table, 42"D x 72"L x 36"H
C2V28-C4284R-36	Cesar Rectangle Table, 42"D x 84"L x 36"H
C2V32-C4860R-36	Cesar Rectangle Table, 48"D x 60"L x 36"H
C2V32-C4872R-36	Cesar Rectangle Table, 48"D x 72"L x 36"H
C2V32-C4884R-36	Cesar Rectangle Table, 48"D x 84"L x 36"H
42"H, T-Base, Radiused Corners, PVC Edge	
CT20-C2436R-42	Cesar Rectangle Table, 24"D x 36"L x 42"H
CT20-C2448R-42	Cesar Rectangle Table, 24"D x 48"L x 42"H
CT20-C2460R-42	Cesar Rectangle Table, 24"D x 60"L x 42"H
CT20-C2472R-42	Cesar Rectangle Table, 24"D x 72"L x 42"H
CT26-C3048R-42	Cesar Rectangle Table, 30"D x 48"L x 42"H
CT26-C3060R-42	Cesar Rectangle Table, 30"D x 60"L x 42"H
CT26-C3072R-42	Cesar Rectangle Table, 30"D x 72"L x 42"H
CT26-C3648R-42	Cesar Rectangle Table, 36"D x 48"L x 42"H
CT26-C3660R-42	Cesar Rectangle Table, 36"D x 60"L x 42"H
CT26-C3672R-42	Cesar Rectangle Table, 36"D x 72"L x 42"H
42"H, VTT-Base, Radiused Corners, PVC Edge	
C2V28-C4260R-42	Cesar Rectangle Table, 42"D x 60"L x 42"H
C2V28-C4272R-42	Cesar Rectangle Table, 42"D x 72"L x 42"H
C2V28-C4284R-42	Cesar Rectangle Table, 42"D x 84"L x 42"H
C2V32-C4860R-42	Cesar Rectangle Table, 48"D x 60"L x 42"H
C2V32-C4872R-42	Cesar Rectangle Table, 48"D x 72"L x 42"H
C2V32-C4884R-42	Cesar Rectangle Table, 48"D x 84"L x 42"H

Required Item: Reading/Studying Tables

Additional Line: Cesar Tables cont'd

Cesar Round Tables

Model Number	Description
18"H, X-Base, PVC Edge	
CX20-C0024-18	Cesar Round Table, 24"Diameter x 18"H
CX26-C0030-18	Cesar Round Table, 30"Diameter x 18"H
29"H, X-Base, PVC Edge	
CX20-C0024-29	Cesar Round Table, 24"Diameter x 29"H
CX26-C0030-29	Cesar Round Table, 30"Diameter x 29"H
CX26-C0036-29	Cesar Round Table, 36"Diameter x 29"H
29"H, 4X-Base, PVC Edge	
C4X38-C0048-29	Cesar Round Table, 48"Diameter x 29"H
C4X44-C0054-29	Cesar Round Table, 54"Diameter x 29"H
C4X44-C0060-29	Cesar Round Table, 60"Diameter x 29"H
36"H, X-Base, PVC Edge	
CX20-C0024-36	Cesar Round Table, 24"Diameter x 36"H
CX26-C0030-36	Cesar Round Table, 30"Diameter x 36"H
CX26-C0036-36	Cesar Round Table, 36"Diameter x 36"H
36"H, 4X-Base, PVC Edge	
C4X38-C0048-36	Cesar Round Table, 48"Diameter x 36"H
C4X44-C0054-36	Cesar Round Table, 54"Diameter x 36"H
C4X44-C0060-36	Cesar Round Table, 60"Diameter x 36"H
42"H, X-Base, PVC Edge	
CX20-C0024-42	Cesar Round Table, 24"Diameter x 42"H
CX26-C0030-42	Cesar Round Table, 30"Diameter x 42"H
CX26-C0036-42	Cesar Round Table, 36"Diameter x 42"H
42"H, 4X-Base, PVC Edge	
C4X38-C0048-42	Cesar Round Table, 48"Diameter x 42"H
C4X44-C0054-42	Cesar Round Table, 54"Diameter x 42"H
C4X44-C0060-42	Cesar Round Table, 60"Diameter x 42"H

Cesar Square Tables

Model Number	Description
18"H, X-Base, Square Corners, PVC Edge	
CX20-C2424-18	Cesar Square Table, 24"W x 24"D x 18"H
29"H, X-Base, Square Corners, PVC Edge	
CX20-C2424-29	Cesar Square Table, 24"W x 24"D x 29"H
CX26-C3030-29	Cesar Square Table, 30"W x 30"D x 29"H
29"H, 4X-Base, Square Corners, PVC Edge	
C4X38-C4242-29	Cesar Square Table, 42"W x 42"D x 29"H
C4X38-C4848-29	Cesar Square Table, 48"W x 48"D x 29"H
C4X44-C5454-29	Cesar Square Table, 54"W x 54"D x 29"H
C4X44-C6060-29	Cesar Square Table, 60"W x 60"D x 29"H
36"H, X-Base, Square Corners, PVC Edge	
CX20-C2424-36	Cesar Square Table, 24"W x 24"D x 36"H
CX26-C3030-36	Cesar Square Table, 30"W x 30"D x 36"H
36"H, 4X-Base, Square Corners, PVC Edge	
C4X38-C4242-36	Cesar Square Table, 42"W x 42"D x 36"H
C4X38-C4848-36	Cesar Square Table, 48"W x 48"D x 36"H
C4X44-C5454-36	Cesar Square Table, 54"W x 54"D x 36"H
C4X44-C6060-36	Cesar Square Table, 60"W x 60"D x 36"H

Cesar Square Tables with Radiused Corners

Model Number	Description
29"H, X-Base, Radiused Corners, PVC Edge	
CX20-C2424R-29	Cesar Square Table, 24"W x 24"D x 29"H
CX26-C3030R-29	Cesar Square Table, 30"W x 30"D x 29"H
29"H, 4X-Base, Radiused Corners, PVC Edge	
C4X38-C4242R-29	Cesar Square Table, 42"W x 42"D x 29"H
C4X38-C4848R-29	Cesar Square Table, 48"W x 48"D x 29"H
C4X44-C5454R-29	Cesar Square Table, 54"W x 54"D x 29"H
C4X44-C6060R-29	Cesar Square Table, 60"W x 60"D x 29"H
36"H, X-Base, Radiused Corners, PVC Edge	
CX20-C2424R-36	Cesar Square Table, 24"W x 24"D x 36"H
CX26-C3030R-36	Cesar Square Table, 30"W x 30"D x 36"H
36"H, 4X-Base, Radiused Corners, PVC Edge	
C4X38-C4242R-36	Cesar Square Table, 42"W x 42"D x 36"H
C4X38-C4848R-36	Cesar Square Table, 48"W x 48"D x 36"H
C4X44-C5454R-36	Cesar Square Table, 54"W x 54"D x 36"H
C4X44-C6060R-36	Cesar Square Table, 60"W x 60"D x 36"H
42"H, X-Base, Radiused Corners, PVC Edge	
CX20-C2424R-42	Cesar Square Table, 24"W x 24"D x 42"H
CX26-C3030R-42	Cesar Square Table, 30"W x 30"D x 42"H
42"H, 4X-Base, Radiused Corners, PVC Edge	
C4X38-C4242R-42	Cesar Square Table, 42"W x 42"D x 42"H
C4X38-C4848R-42	Cesar Square Table, 48"W x 48"D x 42"H
C4X44-C5454R-42	Cesar Square Table, 54"W x 54"D x 42"H
C4X44-C6060R-42	Cesar Square Table, 60"W x 60"D x 42"H

Cesar Clover Top Tables

Model Number	Description
29"H, 4X-Base, PVC Edge	
C4X38-C4848CL-29	Cesar Clover Table, 48"W x 48"D x 29"H
C4X44-C5454CL-29	Cesar Clover Table, 54"W x 54"D x 29"H
C4X44-C6060CL-29	Cesar Clover Table, 60"W x 60"D x 29"H
36"H, 4X-Base, PVC Edge	
C4X38-C4848CL-36	Cesar Clover Table, 48"W x 48"D x 36"H
C4X44-C5454CL-36	Cesar Clover Table, 54"W x 54"D x 36"H
C4X44-C6060CL-36	Cesar Clover Table, 60"W x 60"D x 36"H
42"H, 4X-Base, PVC Edge	
C4X38-C4848CL-42	Cesar Clover Table, 48"W x 48"D x 42"H
C4X44-C5454CL-42	Cesar Clover Table, 54"W x 54"D x 42"H
C4X44-C6060CL-42	Cesar Clover Table, 60"W x 60"D x 42"H

Cesar Sprocket Top Tables

Model Number	Description
29"H, 3 x S-Base, PVC Edge	
C3S10-C4242S-29	Cesar Sprocket Table, 42"W x 42"D x 29"H
C3S13-C4848S-29	Cesar Sprocket Table, 48"W x 48"D x 29"H
29"H, 3 x T-Base, PVC Edge	
C3T20-C6060S-29	Cesar Sprocket Table, 60"W x 60"D x 29"H
36"H, 3 x S-Base, PVC Edge	
C3S10-C4242S-36	Cesar Sprocket Table, 42"W x 42"D x 36"H
C3S13-C4848S-36	Cesar Sprocket Table, 48"W x 48"D x 36"H
36"H, 3 x T-Base, PVC Edge	
C3T20-C6060S-36	Cesar Sprocket Table, 60"W x 60"D x 36"H
42"H, 3 x S-Base, PVC Edge	
C3S10-C4242S-42	Cesar Sprocket Table, 42"W x 42"D x 42"H
C3S13-C4848S-42	Cesar Sprocket Table, 48"W x 48"D x 42"H
42"H, 3 x T-Base, PVC Edge	
C3T20-C6060S-42	Cesar Sprocket Table, 60"W x 60"D x 42"H

Cesar Round Top Tables

Model Number	Description
29"H, 3 x S-Base, Radiused Corners, PVC Edge	
C3S10-C4242RG-29	Cesar Round Table, 42"W x 42"D x 29"H
C3S13-C4848RG-29	Cesar Round Table, 48"W x 48"D x 29"H
29"H, 3 x T-Base, Radiused Corners, PVC Edge	
C3T20-C6060RG-29	Cesar Round Table, 60"W x 60"D x 29"H
36"H, 3 x S-Base, Radiused Corners, PVC Edge	
C3S10-C4242RG-36	Cesar Round Table, 42"W x 42"D x 36"H
C3S13-C4848RG-36	Cesar Round Table, 48"W x 48"D x 36"H
36"H, 3 x T-Base, Radiused Corners, PVC Edge	
C3T20-C6060RG-36	Cesar Round Table, 60"W x 60"D x 36"H
42"H, 3 x S-Base, Radiused Corners, PVC Edge	
C3S10-C4242RG-42	Cesar Round Table, 42"W x 42"D x 42"H
C3S13-C4848RG-42	Cesar Round Table, 48"W x 48"D x 42"H
42"H, 3 x T-Base, Radiused Corners, PVC Edge	
C3T20-C6060RG-42	Cesar Round Table, 60"W x 60"D x 42"H

Cesar Flair Top Tables

Model Number	Description
29"H, T-Base, Radiused Corners, PVC Edge	
CT20/26-C3060FLR-29	Cesar Flair Table, 30"D x 60"L x 29"H
36"H, T-Base, Radiused Corners, PVC Edge	
CT20/26-C3060FLR-36	Cesar Flair Table, 30"D x 60"L x 36"H
42"H, T-Base, Radiused Corners, PVC Edge	
CT20/26-C3060FLR-42	Cesar Flair Table, 30"D x 60"L x 42"H

Cesar Wave Top Tables

Model Number	Description
29"H, T-Base, Radiused Corners, PVC Edge	
CT20-C2460WR-29	Cesar Wave Table, 26.5"D x 59.5"L x 29"H
CT26-C3060WR-29	Cesar Wave Table, 32.5"D x 59.5"L x 29"H
36"H, T-Base, Radiused Corners, PVC Edge	
CT20-C2460WR-36	Cesar Wave Table, 26.5"D x 59.5"L x 36"H
CT26-C3060WR-36	Cesar Wave Table, 32.5"D x 59.5"L x 36"H
42"H, T-Base, Radiused Corners, PVC Edge	
CT20-C2460WR-42	Cesar Wave Table, 26.5"D x 59.5"L x 42"H
CT26-C3060WR-42	Cesar Wave Table, 32.5"D x 59.5"L x 42"H

Cesar Beanie Top Tables

Model Number	Description
29"H, T-Base, Radiused Corners, PVC Edge	
CT20-C3060BNR-29	Cesar Beanie Table, 30"D x 60"L x 29"H
36"H, T-Base, Radiused Corners, PVC Edge	
CT20-C3060BNR-36	Cesar Beanie Table, 30"D x 60"L x 36"H
42"H, T-Base, Radiused Corners, PVC Edge	
CT20-C3060BNR-42	Cesar Beanie Table, 30"D x 60"L x 42"H

Cesar Trapezoid Top Tables

Model Number	Description
29"H, T-Base, Radiused Corners, PVC Edge	
CT20-C2460TRAP-29	Cesar Trapezoid Table, 24"D x 60"L x 29"H
CT26-C3072TRAP-29	Cesar Trapezoid Table, 30"D x 72"L x 29"H
36"H, T-Base, Radiused Corners, PVC Edge	
CT20-C2460TRAP-36	Cesar Trapezoid Table, 24"D x 60"L x 36"H
CT26-C3072TRAP-36	Cesar Trapezoid Table, 30"D x 72"L x 36"H
42"H, T-Base, Radiused Corners, PVC Edge	
CT20-C2460TRAP-42	Cesar Trapezoid Table, 24"D x 60"L x 42"H
CT26-C3072TRAP-42	Cesar Trapezoid Table, 30"D x 72"L x 42"H

Required Item: Reading/Studying Tables and Chairs

Proposed Line: Bookmark Chairs



BM-18D

Required Item: Reading/Studying Tables and Chairs

Additional Line: Hannah Chairs



HAN-101

Bookmark Chairs

Key Features

- Solid oak chair frame
- Rear post legs are steam bent and extend from floor to top of back
- All wood seat is saddled. Upholstered seat uses a hardwood frame with spring-suspended support mesh and high density foam cushion
- Upholstery fabric is available from Grade 1 thru 9
- All chairs meet BIFMA standards

Hannah Chairs

Key Features

- Thermoplastic seat and back
- Powder coated steel frame with plastic leveling glides
- Casters available
- Available with/without arms
- Fabric for optional upholstered seat cushion is available from Grade 1 thru 9
- All chairs meet BIFMA standards

Bookmark							
Model Number	Base	Seat	Back	Seat Hgt.	Wt.	COM Yd.	
BM-18A	Post	Wood	Wood	18"	26	N/A	
BM-18B	Post	Wood	Uph	18"	26	1/2	
BM-18C	Post	Uph	Wood	18"	26	2/3	
BM-18D	Post	Uph	Uph	18"	26	7/8	

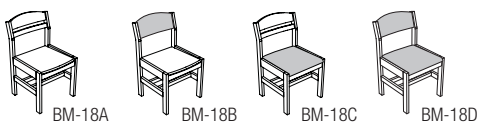

Bookmark Sled Base							
Model Number	Base	Seat	Back	Seat Hgt.	Wt.	COM Yd.	
BM-SB18A	Sled	Wood	Wood	18"	27	N/A	
BM-SB18B	Sled	Wood	Uph	18"	27	1/2	
BM-SB18C	Sled	Uph	Wood	18"	27	2/3	
BM-SB18D	Sled	Uph	Uph	18"	27	7/8	

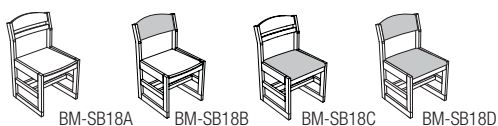

Hannah, Stacker, Armless										
Model Number	Back Material	Seat Material	O.A. Height"	O.A. Width"	Seat Height"	Arm Height"	O.A. Depth"	Back Width"	Back Height"	COM Yd.
HAN001	Plastic	Plastic	29.5	18	18	N/A	18	18	13	N/A
HAN001+	Plastic	Upholstered	29.5	18	19	N/A	18	18	13	1

Hannah, with Arms (Not stackable)										
Model Number	Back Material	Seat Material	O.A. Height"	O.A. Width"	Seat Height"	Arm Height"	O.A. Depth"	Back Width"	Back Height"	COM Yd.
HAN101	Plastic	Plastic	29.5	23.5	18	26.25	18	18	13	N/A
HAN101+	Plastic	Upholstered	29.5	23.5	19	26.25	18	18	13	1

Hannah, 4-Leg, Casters, Armless										
Model Number	Back Material	Seat Material	O.A. Height"	O.A. Width"	Seat Height"	Arm Height"	O.A. Depth"	Back Width"	Back Height"	COM Yd.
HAN005	Plastic	Plastic	29.5	18	18	N/A	18	18	13	N/A
HAN005+	Plastic	Upholstered	29.5	18	19	N/A	18	18	13	1

Hannah, 4-Leg, Casters, with Arms										
Model Number	Back Material	Seat Material	O.A. Height"	O.A. Width"	Seat Height"	Arm Height"	O.A. Depth"	Back Width"	Back Height"	COM Yd.
HAN105	Plastic	Plastic	29.5	23.5	18	26.25	18	18	13	N/A
HAN105+	Plastic	Upholstered	29.5	23.5	19	26.25	18	18	13	1

Hannah, Stool, Counter Height, Armless										
Model Number	Back Material	Seat Material	O.A. Height"	O.A. Width"	Seat Height"	Arm Height"	O.A. Depth"	Back Width"	Back Height"	COM Yd.
HAN008	Plastic	Plastic	35.5	18	24	N/A	18	18	13	N/A
HAN008+	Plastic	Upholstered	35.5	18	25	N/A	18	18	13	1

Hannah, Stool, Counter Height, Armless, with Book/Bag Shelf										
Model Number	Back Material	Seat Material	O.A. Height"	O.A. Width"	Seat Height"	Arm Height"	O.A. Depth"	Back Width"	Back Height"	COM Yd.
HAN508	Plastic	Plastic	35.5	18	24	N/A	18	18	13	N/A
HAN508+	Plastic	Upholstered	35.5	18	25	N/A	18	18	13	1



HAN-005 + HAN600A



HAN008+HAN600A



HAN-508



HAN007+HAN600A



HAN-107



HAN009

Hannah, Stool, Counter Height, with Arms

Model Number	Back Material	Seat Material	O.A. Height"	O.A. Width"	Seat Height"	Arm Height"	O.A. Depth"	Back Width"	Back Height"	COM Yd.
HAN108			35.5	23.5	24	35.25	18	18	13	N/A
HAN108+			35.5	23.5	25	35.25	18	18	13	1

Hannah, Stool, Counter Height, with Arms, with Book/Bag Shelf

Model Number	Back Material	Seat Material	O.A. Height"	O.A. Width"	Seat Height"	Arm Height"	O.A. Depth"	Back Width"	Back Height"	COM Yd.
HAN608			35.5	23.5	24	35.25	18	18	13	N/A
HAN608+			35.5	23.5	25	35.25	18	18	13	1

Hannah, Stool, Bar Height, Armless

Model Number	Back Material	Seat Material	O.A. Height"	O.A. Width"	Seat Height"	Arm Height"	O.A. Depth"	Back Width"	Back Height"	COM Yd.
HAN006	Plastic	Plastic	41.5	18	30	N/A	18	18	13	N/A
HAN006+	Plastic	Upholstered	41.5	18	31	N/A	18	18	13	1

Hannah, Stool, Bar Height, Armless, with Book/Bag Shelf

Model Number	Back Material	Seat Material	O.A. Height"	O.A. Width"	Seat Height"	Arm Height"	O.A. Depth"	Back Width"	Back Height"	COM Yd.
HAN506	Plastic	Plastic	41.5	18	30	N/A	18	18	13	N/A
HAN506+	Plastic	Upholstered	41.5	18	31	N/A	18	18	13	1

Hannah, Stool, Bar Height, with Arms

Model Number	Back Material	Seat Material	O.A. Height"	O.A. Width"	Seat Height"	Arm Height"	O.A. Depth"	Back Width"	Back Height"	COM Yd.
HAN106	Plastic	Plastic	41.5	23.5	30	38.25	18	18	13	N/A
HAN106+	Plastic	Upholstered	41.5	23.5	31	38.25	18	18	13	1

Hannah, Stool, Bar Height, with Arms, with Book/Bag Shelf

Model Number	Back Material	Seat Material	O.A. Height"	O.A. Width"	Seat Height"	Arm Height"	O.A. Depth"	Back Width"	Back Height"	COM Yd.
HAN606	Plastic	Plastic	41.5	23.5	30	38.25	18	18	13	N/A
HAN606+	Plastic	Upholstered	41.5	23.5	31	38.25	18	18	13	1

Hannah, Swivel-tilt Task, Armless

Model Number	Back Material	Seat Material	O.A. Height"	O.A. Width"	Seat Height"	Arm Height"	Seat Depth"	Back Width"	Back Height"	COM Yd.
HAN007	Plastic	Plastic	28.75-32	18	15.75-20.25	N/A	18	18	13	N/A
HAN007+	Plastic	Upholstered	28.75-32	18	16.75-21.25	N/A	18	18	13	1

Hannah, Swivel-tilt Task, with Arms

Model Number	Back Material	Seat Material	O.A. Height"	O.A. Width"	Seat Height"	Arm Height"	Seat Depth"	Back Width"	Back Height"	COM Yd.
HAN107	Plastic	Plastic	28.75-32	23.5	15.75-20.25	24.5-27.75	18	18	13	N/A
HAN107+	Plastic	Upholstered	28.75-32	23.5	16.75-21.25	24.5-27.75	18	18	13	1

Hannah, Swivel-tilt Task Stool, Armless

Model Number	Back Material	Seat Material	O.A. Height"	O.A. Width"	Seat Height"	Arm Height"	Seat Depth"	Back Width"	Back Height"	COM Yd.
HAN009	Plastic	Plastic	36.75-47.75	18	23-33	N/A	18	18	13	N/A
HAN009+	Plastic	Upholstered	36.75-47.75	18	24-34	N/A	18	18	13	1

Hannah, Swivel-tilt Task Stool, with Arms

Model Number	Back Material	Seat Material	O.A. Height"	O.A. Width"	Seat Height"	Arm Height"	Seat Depth"	Back Width"	Back Height"	COM Yd.
HAN109	Plastic	Plastic	36.75-47.75	23.5	23-33	30.47-40.75	18	18	13	N/A
HAN109+	Plastic	Upholstered	36.75-47.75	23.5	24-34	30.47-40.75	18	18	13	1

Hannah, Upholstered Seat Cushion

Model Number										
HAN600A-										

Required Item: Reading/Studying Tables and Chairs

Additional Line: Arc Chairs



ARC-N55F43WST



Arc Chairs

Key Features

- Seat and back available in combinations of thermo plastic, veneer and upholstery
- Powder coated steel frame with plastic glides
- Available with/without arms
- Fabric for optional upholstered seat cushion is available from Grade 1 thru 9
- All chairs meet BIFMA standards

Arc Task Chair, Mid Back, Swivel, Armless

Model Number	Back Material	Seat Material	O.A. Width"	O.A. Height"	Arm Height"	Seat Depth"	Seat Width"	Seat Height"	Back Width"	Back Height"	COM Yd.
ARC-G55D43W	Wood Ply	Wood Ply	26	29-33-1/2	N/A	18	18-1/2	16-20-1/2	17-1/2	14"	N/A
ARC-G55D43P	Thermoplastic	Thermoplastic	26	29-33-1/2	N/A	18	18-1/2	16-20-1/2	17-1/2	14"	N/A
ARC-G55D43-	Upholstered	Upholstered	26	29-33-1/2	N/A	18	18-1/2	16-20-1/2	17-1/2	14"	1.2
ARC-G55D43DW-	Wood Ply	Upholstered	26	29-33-1/2	N/A	18	18-1/2	16-20-1/2	17-1/2	14"	0.6
ARC-G55D43DP-	Thermoplastic	Upholstered	26	29-33-1/2	N/A	18	18-1/2	16-20-1/2	17-1/2	14"	0.6

Arc Task Chair, Mid Back, Swivel, Loop Arm

Model Number	Back Material	Seat Material	O.A. Width"	O.A. Height"	Arm Height"	Seat Depth"	Seat Width"	Seat Height"	Back Width"	Back Height"	COM Yd.
ARC-G55D42W	Wood Ply	Wood Ply	26	29-33-1/2	23-3/4-28-1/4	18	18-1/2	16-20-1/2	17-1/2	14"	N/A
ARC-G55D42P	Thermoplastic	Thermoplastic	26	29-33-1/2	23-3/4-28-1/4	18	18-1/2	16-20-1/2	17-1/2	14"	N/A
ARC-G55D42-	Upholstered	Upholstered	26	29-33-1/2	23-3/4-28-1/4	18	18-1/2	16-20-1/2	17-1/2	14"	1.2
ARC-G55D42DW-	Wood Ply	Upholstered	26	29-33-1/2	23-3/4-28-1/4	18	18-1/2	16-20-1/2	17-1/2	14"	0.6
ARC-G55D42DP-	Thermoplastic	Upholstered	26	29-33-1/2	23-3/4-28-1/4	18	18-1/2	16-20-1/2	17-1/2	14"	0.6

Arc, Mid Back, 4 Leg, Armless

Model Number	Back Material	Seat Material	O.A. Width"	O.A. Height"	Arm Height"	Seat Depth"	Seat Width"	Seat Height"	Back Width"	Back Height"	COM Yd.
ARC-N55F43W	Wood Ply	Wood Ply	19	31	N/A	18	18-1/2	18	17-1/2	14"	N/A
ARC-N55F43P	Thermoplastic	Thermoplastic	19	31	N/A	18	18-1/2	18	17-1/2	14"	N/A
ARC-N55F43-	Upholstered	Upholstered	19	31	N/A	18	18-1/2	18	17-1/2	14"	1.2
ARC-N55F43DW-	Wood Ply	Upholstered	19	31	N/A	18	18-1/2	18	17-1/2	14"	0.6
ARC-N55F43DP-	Thermoplastic	Upholstered	19	31	N/A	18	18-1/2	18	17-1/2	14"	0.6

Arc, Mid Back, 4 Leg, Loop Arm

Model Number	Back Material	Seat Material	O.A. Width"	O.A. Height"	Arm Height"	Seat Depth"	Seat Width"	Seat Height"	Back Width"	Back Height"	COM Yd.
ARC-N55F42W	Wood Ply	Wood Ply	19	31	25-3/4	18	18-1/2	18	17-1/2	14"	N/A
ARC-N55F42P	Thermoplastic	Thermoplastic	19	31	25-3/4	18	18-1/2	18	17-1/2	14"	N/A
ARC-N55F42-	Upholstered	Upholstered	19	31	25-3/4	18	18-1/2	18	17-1/2	14"	1.2
ARC-N55F42DW	Wood Ply	Upholstered	19	31	25-3/4	18	18-1/2	18	17-1/2	14"	0.6
ARC-N55F42DP	Thermoplastic	Upholstered	19	31	25-3/4	18	18-1/2	18	17-1/2	14"	0.6

Arc, Mid Back, 4 Leg, Stacker, Armless

Model Number	Back Material	Seat Material	O.A. Width"	O.A. Height"	Arm Height"	Seat Depth"	Seat Width"	Seat Height"	Back Width"	Back Height"	COM Yd.
ARC-N55F43WST	Wood Ply	Wood Ply	19	31	N/A	18	18-1/2	18	17-1/2	14"	N/A
ARC-N55F43PST	Thermoplastic	Thermoplastic	19	31	N/A	18	18-1/2	18	17-1/2	14"	N/A
ARC-N55F43ST-	Upholstered	Upholstered	19	31	N/A	18	18-1/2	18	17-1/2	14"	1.2
ARC-N55F43DWST	Wood Ply	Upholstered	19	31	N/A	18	18-1/2	18	17-1/2	14"	0.6
ARC-N55F43DPST	Thermoplastic	Upholstered	19	31	N/A	18	18-1/2	18	17-1/2	14"	0.6

Arc, Mid Back, 4 Leg, Stacker, Loop Arm

Model Number	Back Material	Seat Material	O.A. Width"	O.A. Height"	Arm Height"	Seat Depth"	Seat Width"	Seat Height"	Back Width"	Back Height"	COM Yd.
ARC-N55F42WST	Wood Ply	Wood Ply	19	31	25-3/4	18	18-1/2	18	17-1/2	14"	N/A
ARC-N55F42PST	Thermoplastic	Thermoplastic	19	31	25-3/4	18	18-1/2	18	17-1/2	14"	N/A
ARC-N55F42ST-	Upholstered	Upholstered	19	31	25-3/4	18	18-1/2	18	17-1/2	14"	1.2
ARC-N55F42DWST	Wood Ply	Upholstered	19	31	25-3/4	18	18-1/2	18	17-1/2	14"	0.6
ARC-N55F42DPST	Thermoplastic	Upholstered	19	31	25-3/4	18	18-1/2	18	17-1/2	14"	0.6



ARC-G55D43P



ARC-N55E43P



ARC-G55D42P

Arc, Mid Back, Sled Base, Armless

Model Number	Back Material	Seat Material	O.A. Width"	O.A. Height"	Arm Height"	Seat Depth"	Seat Width"	Seat Height"	Back Width"	Back Height"	COM Yd.
ARC-N55E43W	Wood Ply	Wood Ply	19	31	N/A	18	18-1/2	18	17-1/2	14"	N/A
ARC-N55E43P	Thermoplastic	Thermoplastic	19	31	N/A	18	18-1/2	18	17-1/2	14"	N/A
ARC-N55E43-	Upholstered	Upholstered	19	31	N/A	18	18-1/2	18	17-1/2	14"	1.2
ARC-N55E43DW	Wood Ply	Upholstered	19	31	N/A	18	18-1/2	18	17-1/2	14"	0.6
ARC-N55E43DP	Thermoplastic	Upholstered	19	31	N/A	18	18-1/2	18	17-1/2	14"	0.6

Arc, Mid Back, Sled Base, Loop Arms

Model Number	Back Material	Seat Material	O.A. Width"	O.A. Height"	Arm Height"	Seat Depth"	Seat Width"	Seat Height"	Back Width"	Back Height"	COM Yd.
ARC-N55E42W	Wood Ply	Wood Ply	19	31	25-3/4	18	18-1/2	18	17-1/2	14"	N/A
ARC-N55E42P	Thermoplastic	Thermoplastic	19	31	25-3/4	18	18-1/2	18	17-1/2	14"	N/A
ARC-N55E42-	Upholstered	Upholstered	19	31	25-3/4	18	18-1/2	18	17-1/2	14"	1.2
ARC-N55E42DW	Wood Ply	Upholstered	19	31	25-3/4	18	18-1/2	18	17-1/2	14"	0.6
ARC-N55E42DP	Thermoplastic	Upholstered	19	31	25-3/4	18	18-1/2	18	17-1/2	14"	0.6

Arc, Stool, Counter Height, Armless

Model Number	Back Material	Seat Material	O.A. Width"	O.A. Height"	Arm Height"	Seat Depth"	Seat Width"	Seat Height"	Back Width"	Back Height"	COM Yd.
ARC-S55F43WCH	Wood Ply	Wood Ply	19	38	N/A	18	18-1/2	25	17-1/2	14"	N/A
ARC-S55F43PCH	Thermoplastic	Thermoplastic	19	38	N/A	18	18-1/2	25	17-1/2	14"	N/A
ARC-S55F43CH-	Upholstered	Upholstered	19	38	N/A	18	18-1/2	25	17-1/2	14"	1.2
ARC-S55F43DWCH	Wood Ply	Upholstered	19	38	N/A	18	18-1/2	25	17-1/2	14"	0.6
ARC-S55F43DPCH	Thermoplastic	Upholstered	19	38	N/A	18	18-1/2	25	17-1/2	14"	0.6

Arc, Stool, Counter Height, Loop Arm

Model Number	Back Material	Seat Material	O.A. Width"	O.A. Height"	Arm Height"	Seat Depth"	Seat Width"	Seat Height"	Back Width"	Back Height"	COM Yd.
ARC-S55F42WCH	Wood Ply	Wood Ply	25	38	32-3/4	18	18-1/2	25	17-1/2	14"	N/A
ARC-S55F42PCH	Thermoplastic	Thermoplastic	25	38	32-3/4	18	18-1/2	25	17-1/2	14"	N/A
ARC-S55F42CH-	Upholstered	Upholstered	25	38	32-3/4	18	18-1/2	25	17-1/2	14"	1.2
ARC-S55F42DWCH	Wood Ply	Upholstered	25	38	32-3/4	18	18-1/2	25	17-1/2	14"	0.6
ARC-S55F42DPCH	Thermoplastic	Upholstered	25	38	32-3/4	18	18-1/2	25	17-1/2	14"	0.6

Arc, Stool, Bar Height, Armless

Model Number	Back Material	Seat Material	O.A. Width"	O.A. Height"	Arm Height"	Seat Depth"	Seat Width"	Seat Height"	Back Width"	Back Height"	COM Yd.
ARC-S55F43WBH	Wood Ply	Wood Ply	19	41	N/A	18	18-1/2	28	17-1/2	14"	N/A
ARC-S55F43PBH	Thermoplastic	Thermoplastic	19	41	N/A	18	18-1/2	28	17-1/2	14"	N/A
ARC-S55F43BH-	Upholstered	Upholstered	19	41	N/A	18	18-1/2	28	17-1/2	14"	1.2
ARC-S55F43DWBH	Wood Ply	Upholstered	19	41	N/A	18	18-1/2	28	17-1/2	14"	0.6
ARC-S55F43DPBH	Thermoplastic	Upholstered	19	41	N/A	18	18-1/2	28	17-1/2	14"	0.6

Arc, Stool, Bar Height, Loop Arm

Model Number	Back Material	Seat Material	O.A. Width"	O.A. Height"	Arm Height"	Seat Depth"	Seat Width"	Seat Height"	Back Width"	Back Height"	COM Yd.
ARC-S55F42WBH	Wood Ply	Wood Ply	25	41	35-3/4	18	18-1/2	28	17-1/2	14"	N/A
ARC-S55F42PBH	Thermoplastic	Thermoplastic	25	41	35-3/4	18	18-1/2	28	17-1/2	14"	N/A
ARC-S55F42BH-	Upholstered	Upholstered	25	41	35-3/4	18	18-1/2	28	17-1/2	14"	1.2
ARC-S55F42DWBH	Wood Ply	Upholstered	25	41	35-3/4	18	18-1/2	28	17-1/2	14"	0.6
ARC-S55F42DPBH	Thermoplastic	Upholstered	25	41	35-3/4	18	18-1/2	28	17-1/2	14"	0.6

Required Item: Bookstacks

Proposed Line: Bookmark 21-Series

Additional Lines: Metro, Heritage, Charleston, Malibu, Lexington

16



V21-7212
Single Faced
Unit

Bookmark 21-Series Bookcases

- Premium oak or maple veneer
- Veneer core shelves
- Premium oak banding
- Box frame toe
- Bookshelf and picturebook shelves
- Steel, solid wood & magazine shelves optional
- Multiple oak and maple finishes
- 9 tough epoxy Sprayon finishes
- End panels pre-drilled for optional leveling glides
- 42" and 48"H double-faced mobile bookcases



V21-4224
Double Faced
Unit

BOOKMARK 21-SERIES

Starter-Adder Configurations for Extended Runs



Starter V21-4212



Adder V21-4212A

Bookshelf and Picturebook Bookcases



SB21-4224P
Steel Picturebook
Shelving



V21-4224P
Wood Picturebook
Shelving

Alternatives to Veneer Core Shelves



SB21-7212
Steel Shelves

Steel Shelves

Steel shelves may be specified. Remove the "V" and add "SB" to the model number prefix. (i.e. SB21-7212).

Solid Wood Shelves

Solid wood bookshelves may be specified for wood veneer bookcases. Remove the "V" from the model number prefix. (i.e. 21-7212).

Magazine Shelves

Magazine shelves must be ordered separately.



21-7212
Solid Wood Shelves

Finish Options



Powder Coat
Steel Shelving

Finishes on Veneer

- 7 finishes on oak
- 6 finishes on maple

Sprayon

Sprayon is an epoxy paint.

- 9 Sprayon colors

Powder Coat

- 19 powder coat colors

To see our palette of finishes visit mediatechnologies.com/resources/finishes or contact your mediatechnologies sales representative.



Shown with
Sprayon Finish

See Finishes at www.mediatechnologies.com/resources/finishes

Wood Shelf Options

V21-08SH	8" D wood veneer shelf
V21-10SH	10" D wood veneer shelf
V21-12SH	12" D wood veneer shelf
V21-16SH	16" D wood veneer shelf
V21-12SH-MAG	12" wood magazine shelf
V21-12SH-PB	12" wood picture book shelf
V11-12SH-PB-DIV	Wood picture book divider
31-LK	Adjustable Glides (set of 2)
(2 glides are required for each vertical panel)	

Steel Shelf Options

SB321-08SH	8" D flat steel bookcase shelf
SB321-10SH	10" D flat steel bookcase shelf
SB321-12SH	12" D flat steel bookcase shelf
SB321-14SH	14" D flat steel bookcase shelf
S21-12SH-MAG	12" D steel picture book shelf
S321-12SH-PB-DIV	Steel picture book divider
S321-12SH-BB	12" D steel browser bin
21-BS10	10" L x 4" H sliding book support for steel shelves

Adding Magazine Shelves



Bookcase

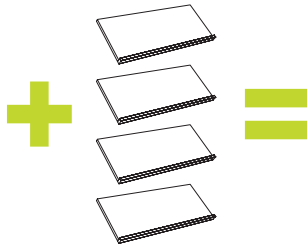

21-12SH-MAG (Wood)
S21-SH-MAG (Steel)



Bookcase with Magazine Shelves

How to Order a Bookcase with Magazine Shelves

1. Order your Bookcase.
2. Order the Number of Magazine Shelves you need.
3. Arrange and Space your Bookcase Shelves and Install your Magazine Shelves (you may need to remove a shelf).



V21-4210
V21-4210A Adder
V21-4212
V21-4212A Adder

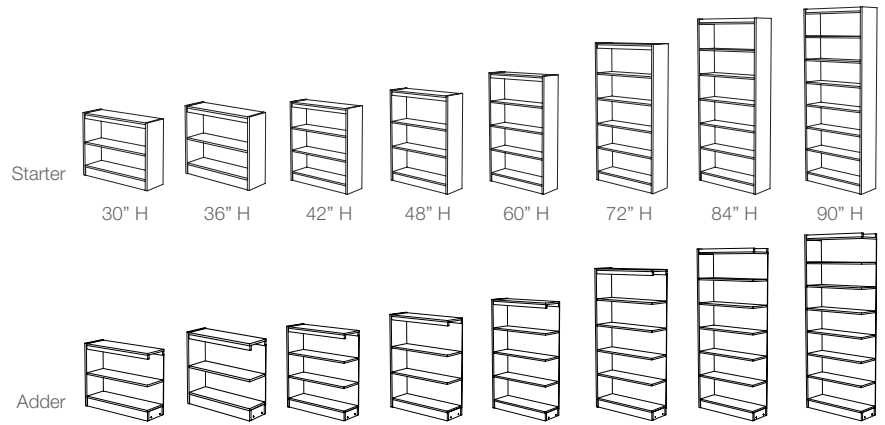

Bookmark Single Faced Units

18



V21-4220
V21-4220A Adder
V21-4224
V21-4224A Adder

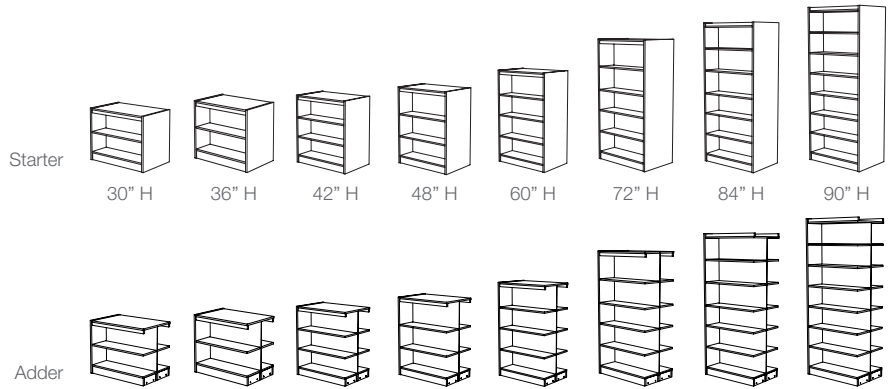

Bookmark Double Faced Units



V21-4212P
V21-4212A Adder

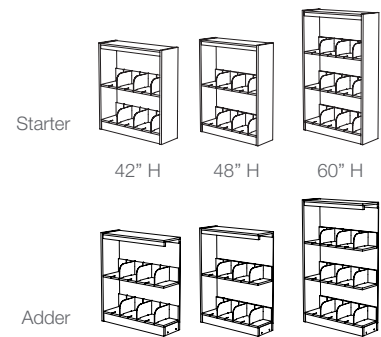

Bookmark Picture Book Single Faced Units



V21-4224P
V21-4224PA Adder

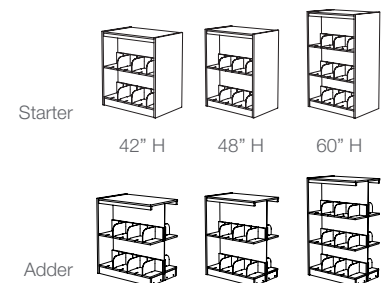

Bookmark Picture Book Double Faced Units

* Steel shelves may be specified for most wood bookcases. Replace "V" in the model with "SB" (i.e. SB21-4220).

BOOKMARK 21-SERIES

Single Faced Standard Units

30" High	Model Number	Description	Wt.
	V21-3008	30"H X 37"W X 8"D Initial	38
	V21-3008A	30"H X 36"W X 8"D Adder	33
	V21-3010	30"H X 37"W X 10"D Initial	43
	V21-3010A	30"H X 36"W X 10"D Adder	37
	V21-3012	30"H X 37"W X 12"D Initial	49
	V21-3012A	30"H X 36"W X 12"D Adder	42

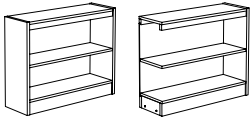

30" High single sided shelving has a select wood top and one adjustable shelf. Includes 1/4" matching wood back.

36" High	Model Number	Description	Wt.
	V21-3608	36"H X 37"W X 8"D Initial	43
	V21-3608A	36"H X 36"W X 8"D Adder	37
	V21-3610	36"H X 37"W X 10"D Initial	49
	V21-3610A	36"H X 36"W X 10"D Adder	42
	V21-3612	36"H X 37"W X 12"D Initial	56
	V21-3612A	36"H X 36"W X 12"D Adder	48

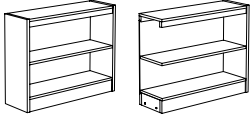

36" High single sided shelving has a select wood top and one adjustable shelf. Includes 1/4" matching wood back.

42" High	Model Number	Description	Wt.
	V21-4208	42"H X 37"W X 8"D Initial	47
	V21-4208A	42"H X 36"W X 8"D Adder	41
	V21-4210	42"H X 37"W X 10"D Initial	55
	V21-4210A	42"H X 36"W X 10"D Adder	47
	V21-4212	42"H X 37"W X 12"D Initial	62
	V21-4212A	42"H X 36"W X 12"D Adder	53
	V21-4216-SF	42"H X 37"W X 16"D Initial	77
	V21-4216A-SF	42"H X 36"W X 16"D Adder	64

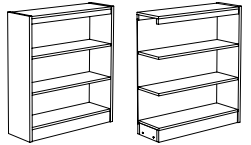

42" High single sided shelving has a wood top and two adjustable shelves. Includes 1/4" matching wood back.

48" High	Model Number	Description	Wt.
	V21-4808	48"H X 37"W X 8"D Initial	50
	V21-4808A	48"H X 36"W X 8"D Adder	43
	V21-4810	48"H X 37"W X 10"D Initial	59
	V21-4810A	48"H X 36"W X 10"D Adder	49
	V21-4812	48"H X 37"W X 12"D Initial	66
	V21-4812A	48"H X 36"W X 12"D Adder	56
	V21-4816-SF	48"H X 37"W X 16"D Initial	82
	V21-4816A-SF	48"H X 36"W X 16"D Adder	67

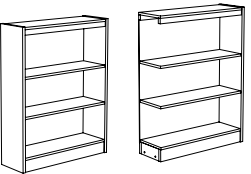

48" High single sided shelving has a wood top and two adjustable shelves. Includes 1/4" matching wood back.

60" High	Model Number	Description	Wt.
	V21-6008	60"H X 37"W X 8"D Initial	59
	V21-6008A	60"H X 36"W X 8"D Adder	50
	V21-6010	60"H X 37"W X 10"D Initial	69
	V21-6010A	60"H X 36"W X 10"D Adder	58
	V21-6012	60"H X 37"W X 12"D Initial	79
	V21-6012A	60"H X 36"W X 12"D Adder	65
	V21-6016-SF	60"H X 37"W X 16"D Initial	98
	V21-6016A-SF	60"H X 36"W X 16"D Adder	80

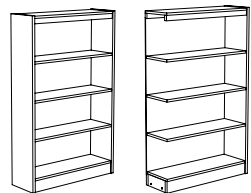

60" High single sided shelving has a wood top and three adjustable shelves. Includes 1/4" matching wood back.

72" High	Model Number	Description	Wt.
	V21-7208	72"H X 37"W X 8"D Initial	72
	V21-7208A	72"H X 36"W X 8"D Adder	59
	V21-7210	72"H X 37"W X 10"D Initial	84
	V21-7210A	72"H X 36"W X 10"D Adder	68
	V21-7212	72"H X 37"W X 12"D Initial	97
	V21-7212A	72"H X 36"W X 12"D Adder	78
	V21-7216-SF	72"H X 37"W X 16"D Initial	121
	V21-7216A-SF	72"H X 36"W X 16"D Adder	95

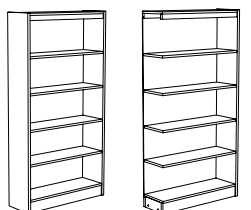

72" High single sided shelving has a wood top and four adjustable shelves. Includes 1/4" matching wood back.

84" High	Model Number	Description	Wt.
	V21-8408	84"H X 37"W X 8"D Initial	79
	V21-8408A	84"H X 36"W X 8"D Adder	66
	V21-8410	84"H X 37"W X 10"D Initial	92
	V21-8410A	84"H X 36"W X 10"D Adder	76
	V21-8412	84"H X 37"W X 12"D Initial	106
	V21-8412A	84"H X 36"W X 12"D Adder	87
	V21-8416-SF	84"H X 37"W X 16"D Initial	133
	V21-8416A-SF	84"H X 36"W X 16"D Adder	107

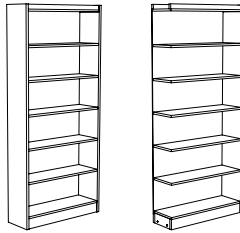

84" High single sided shelving has an inverted wood cornice top and five adjustable shelves. Includes 1/4" matching wood back.

90" High	Model Number	Description	Wt.
	V21-9012	90"H X 37"W X 12"D Initial	115
	V21-9012A	90"H X 36"W X 12"D Adder	95

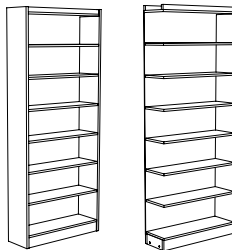

90" High single sided shelving has an inverted wood cornice top and six adjustable shelves. Includes 1/4" matching wood back.

Double Faced Standard Units

30" High	Model Number	Description	Wt.
	V21-3020	30"H X 36"W X 20"D Initial	79
	V21-3020A	30"H X 36"W X 20"D Adder	68
	V21-3024	30"H X 37"W X 24"D Initial	90
	V21-3024A	30"H X 36"W X 24"D Adder	76

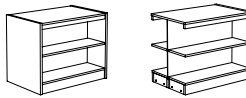

30" High double sided shelving has a wood top and two adjustable shelves. Includes 1/4" matching wood back.

30" High Mobile Units	Model Number	Description	Wt.
	V21-3020-MOB	30"H X 37"W X 20"D Initial Mobile	91
	V21-3020A-MOB	30"H X 36"W X 20"D Adder Mobile	80
	V21-3024-MOB	30"H X 37"W X 24"D Mobile	102
	V21-3024A-MOB	30"H X 36"W X 20"D Adder Mobile	88

36" High	Model Number	Description	Wt.
	V21-3620	36"H X 36"W X 20"D Initial	90
	V21-3620A	36"H X 36"W X 20"D Adder	76
	V21-3624	36"H X 37"W X 24"D Initial	103
	V21-3624A	36"H X 36"W X 24"D Adder	86

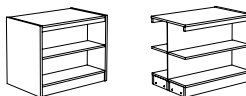

36" High double sided shelving has a wood top and two adjustable shelves. Includes 1/4" matching wood back.

36" High Mobile Units	Model Number	Description	Wt.
	V21-3620-MOB	36"H X 37"W X 20"D Initial Mobile	102
	V21-3620A-MOB	36"H X 36"W X 20"D Adder Mobile	88
	V21-3624-MOB	36"H X 37"W X 24"D Mobile	115
	V21-3624A-MOB	36"H X 36"W X 20"D Adder Mobile	98

42" High	Model Number	Description	Wt.
	V21-4220	42"H X 37"W X 20"D Initial	100
	V21-4220A	42"H X 36"W X 20"D Adder	84
	V21-4224	42"H X 37"W X 24"D Initial	115
	V21-4224A	42"H X 36"W X 24"D Adder	96

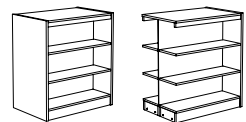

42" High double sided shelving has a wood top and four adjustable shelves. Includes 1/4" matching wood back.

42" High Mobile Units	Model Number	Description	Wt.
	V21-4220-MOB	42"H X 37"W X 20"D Initial Mobile	112
	V21-4220A-MOB	42"H X 36"W X 20"D Adder Mobile	96
	V21-4224-MOB	42"H X 37"W X 24"D Initial Mobile	127
	V21-4224A-MOB	42"H X 36"W X 24"D Adder Mobile	108

* Steel shelves may be specified for most wood bookcases. Replace "V" in the model with "SB" (i.e. SB21-4220).

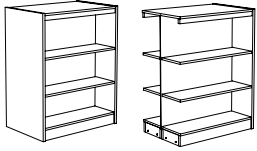
48" High	Model Number	Description	Wt.
	V21-4820	48"H X 37"W X 20"D Initial	105
	V21-4820A	48"H X 36"W X 20"D Adder	86
	V21-4824	48"H X 37"W X 24"D Initial	121
	V21-4824A	48"H X 36"W X 24"D Adder	99

48" High double sided shelving has a wood top and four adjustable shelves. Includes 1/4" matching wood back.

48" High Mobile Units	Model Number	Description	Wt.
	V21-4820-MOB	48"H X 37"W X 20"D Initial Mobile	117
	V21-4820A-MOB	48"H X 36"W X 20"D Adder Mobile	98
	V21-4824-MOB	48"H X 37"W X 24"D Initial Mobile	133
	V21-4824A-MOB	48"H X 36"W X 24"D Adder Mobile	111

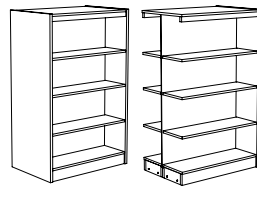
60" High	Model Number	Description	Wt.
	V21-6020	60"H X 37"W X 20"D Initial	125
	V21-6020A	60"H X 36"W X 20"D Adder	102
	V21-6024	60"H X 37"W X 24"D Initial	144
	V21-6024A	60"H X 36"W X 24"D Adder	117

60" High double sided shelving has a wood top and six adjustable shelves. Includes 1/4" matching wood back.

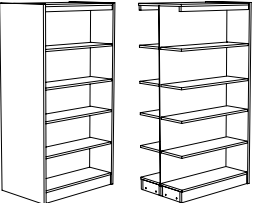
72" High	Model Number	Description	Wt.
	V21-7220	72"H X 37"W X 20"D Initial	151
	V21-7220A	72"H X 36"W X 20"D Adder	119
	V21-7224	72"H X 37"W X 24"D Initial	176
	V21-7224A	72"H X 36"W X 24"D Adder	138

72" High double sided shelving has a wood top and eight adjustable shelves. Includes 1/4" matching wood back.

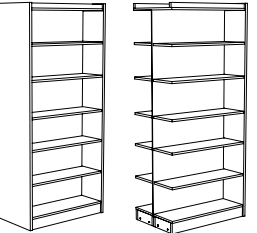
84" High	Model Number	Description	Wt.
	V21-8420	84"H X 37"W X 20"D Initial	167
	V21-8420A	84"H X 36"W X 20"D Adder	135
	V21-8424	84"H X 37"W X 24"D Initial	194
	V21-8424A	84"H X 36"W X 24"D Adder	156

84" High double sided shelving has an inverted wood cornice top and ten adjustable shelves. Includes 1/4" matching wood back.

90" High	Model Number	Description	Wt.
	21-9024	90"H X 37"W X 24"D Initial	212
	21-9024A	90"H X 36"W X 24"D Adder	172

90" High double sided shelving has an inverted wood cornice top and twelve adjustable shelves. Includes 1/4" matching wood back.

Single Faced Picture Book Units

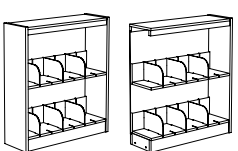
42" High	Model Number	Description	Wt.
	V21-4212P	42"H X 37"W X 12"D Initial	72
	V21-4212PA	42"H X 36"W X 12"D Adder	63

42" High single sided shelving has a wood top, one adjustable picture book shelf and one base picture book shelf. Includes 1/4" matching wood back.

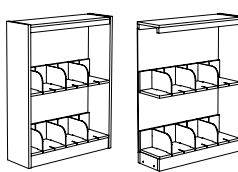
48" High	Model Number	Description	Wt.
	V21-4812P	48"H X 37"W X 12"D Initial	75
	V21-4812PA	48"H X 36"W X 12"D Adder	64

48" High single sided shelving has a wood top, one adjustable picture book shelf and one base picture book shelf. Includes 1/4" matching wood back.

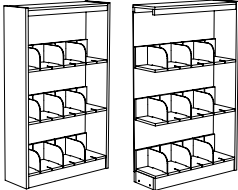
60" High	Model Number	Description	Wt.
	V21-6012P	60"H X 37"W X 12"D Initial	94
	V21-6012PA	60"H X 36"W X 12"D Adder	80

60" High single sided shelving has a wood top, two adjustable picture book shelves and one base picture book shelf. Includes 1/4" matching wood back.

Double Faced Picture Book Units

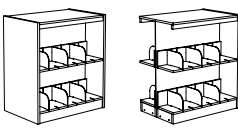
42" High	Model Number	Description	Wt.
	V21-4224P	42"H X 37"W X 24"D Initial	134
	V21-4224PA	42"H X 36"W X 24"D Adder	115

42" High double sided shelving has a wood top, one adjustable picture book shelf and one base picture book shelf per side. Includes 1/4" matching wood back.

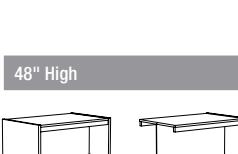
42" High Mobile Unit	Model Number	Description	Wt.
	V21-4224P-MOB	42"H X 37"W X 24"D Initial Mobile	146
	V21-4224PA-MOB	42"H X 36"W X 24"D Adder Mobile	127

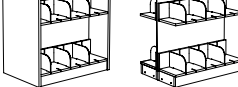
48" High	Model Number	Description	Wt.
	V21-4824P	48"H X 37"W X 24"D Initial	140
	V21-4824PA	48"H X 36"W X 24"D Adder	118

48" High double sided shelving has a wood top, one adjustable picture book shelf and one base picture book shelf per side. Includes 1/4" matching wood back.

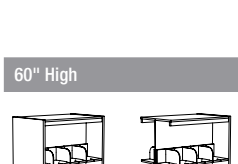
48" High Mobile Unit	Model Number	Description	Wt.
	V21-4824P-MOB	48"H X 37"W X 24"D Initial Mobile	152
	V21-4824PA-MOB	48"H X 36"W X 24"D Adder Mobile	130

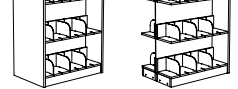
60" High	Model Number	Description	Wt.
	21-6024P	60"H X 37"W X 24"D Initial	174
	21-6024PA	60"H X 36"W X 24"D Adder	147

60" High double sided shelving has a wood top, two adjustable picture book shelves and one base picture book shelf per side. Includes 1/4" matching wood back.

* Steel shelves may be specified for most wood bookcases. Replace "V" in the model with "SB" (i.e. SB21-4220).

BOOKMARK 21-SERIES

Standard Individual Adjustable Shelves

Wood Bookcase	Model Number	Description	Wt.
	V21-08SH-S	8"D X 34-15/16"W Veneer Core Wood Bookcase Shelf	6
	V21-10SH-S	10"D X 34-15/16"W Veneer Core Wood Bookcase Shelf	7
	V21-12SH-S	12"D X 34-15/16"W Veneer Core Wood Bookcase Shelf	8
	V21-16SH-S	16"D X 34-15/16"W Veneer Core Wood Bookcase Shelf	11

Steel Bookcase	Model Number	Description	Wt.
	SB321-08SH	8"D X 34-15/16"W Flat Steel Bookcase Shelf	7
	SB321-10SH	10"D X 34-15/16"W Flat Steel Bookcase Shelf	9
	SB321-12SH	12"D X 34-15/16"W Flat Steel Bookcase Shelf	10

Magazine Display	Model Number	Description	Wt.
	S21-12SH-MAG	Standard Steel Pivoting Magazine Shelf	11

Picture Book	Model Number	Description	Wt.
	V21-12SH-PB	Standard Wood Picture Book Shelf	15
	S321-12SH-PB	Standard Steel Picture Book Shelf	16
	V11-12SH-PB-DIV	Standard Wood Picture Book Divider	0.5
	S321-12SH-PB-DIV	Standard Steel Picture Book Divider	0.5

Browswer Bins	Model Number	Description	Wt.
	S321-12SH-BB	12" 31, 21, 11 Series Steel Browswer Bins shelf	

Sliding Book Support	Model Number	Description	Wt.
	21-BS10	10"L x 4:H Sliding Book Support for standard steel shelves	0.5

Optional Leveling Glides	Model Number	Description	Wt.
	31-LK	Set of 2 leveling glides	



Required Item: Bookstacks

Additional Lines: Metro



V23-4224

Metro

*Adder vertical panels are undecorated

Single Faced Standard Units

30" High	Model Number	Description	Wt.
	V23-3008	30"H X 37"W X 8"D Initial	38
	V21-3008A	30"H X 36"W X 8"D Adder	33
	V23-3010	30"H X 37"W X 10"D Initial	43
	V21-3010A	30"H X 36"W X 10"D Adder	37
	V23-3012	30"H X 37"W X 12"D Initial	49
	V21-3012A	30"H X 36"W X 12"D Adder	42

30" High single sided shelving has a select wood top and one adjustable shelf.
Includes 1/4" matching wood back.

36" High	Model Number	Description	Wt.
	V23-3608	36"H X 37"W X 8"D Initial	43
	V21-3608A	36"H X 36"W X 8"D Adder	37
	V23-3610	36"H X 37"W X 10"D Initial	49
	V21-3610A	36"H X 36"W X 10"D Adder	42
	V23-3612	36"H X 37"W X 12"D Initial	56
	V21-3612A	36"H X 36"W X 12"D Adder	48

36" High single sided shelving has a select wood top and one adjustable shelf.
Includes 1/4" matching wood back.

42" High	Model Number	Description	Wt.
	V23-4208	42"H X 37"W X 8"D Initial	47
	V21-4208A	42"H X 36"W X 8"D Adder	41
	V23-4210	42"H X 37"W X 10"D Initial	55
	V21-4210A	42"H X 36"W X 10"D Adder	47
	V23-4212	42"H X 37"W X 12"D Initial	62
	V21-4212A	42"H X 36"W X 12"D Adder	53
	V23-4216-SF	42"H X 37"W X 16"D Initial	77
	V21-4216A-SF	42"H X 36"W X 16"D Adder	64

42" High single sided shelving has a wood top and two adjustable shelves.
Includes 1/4" matching wood back.

48" High	Model Number	Description	Wt.
	V23-4808	48"H X 37"W X 8"D Initial	50
	V21-4808A	48"H X 36"W X 8"D Adder	43
	V23-4810	48"H X 37"W X 10"D Initial	59
	V21-4810A	48"H X 36"W X 10"D Adder	49
	V23-4812	48"H X 37"W X 12"D Initial	66
	V21-4812A	48"H X 36"W X 12"D Adder	56
	V23-4816-SF	48"H X 37"W X 16"D Initial	82
	V21-4816A-SF	48"H X 36"W X 16"D Adder	67

48" High single sided shelving has a wood top and two adjustable shelves.
Includes 1/4" matching wood back.

60" High	Model Number	Description	Wt.
	V23-6008	60"H X 37"W X 8"D Initial	59
	V21-6008A	60"H X 36"W X 8"D Adder	50
	V23-6010	60"H X 37"W X 10"D Initial	69
	V21-6010A	60"H X 36"W X 10"D Adder	58
	V23-6012	60"H X 37"W X 12"D Initial	79
	V21-6012A	60"H X 36"W X 12"D Adder	65
	V23-6016-SF	60"H X 37"W X 16"D Initial	98
	V21-6016A-SF	60"H X 36"W X 16"D Adder	80

60" High single sided shelving has a wood top and three adjustable shelves.
Includes 1/4" matching wood back.

72" High	Model Number	Description	Wt.
	V23-7208	72"H X 37"W X 8"D Initial	72
	V21-7208A	72"H X 36"W X 8"D Adder	59
	V23-7210	72"H X 37"W X 10"D Initial	84
	V21-7210A	72"H X 36"W X 10"D Adder	68
	V23-7212	72"H X 37"W X 12"D Initial	98
	V23-7212A	72"H X 37"W X 12"D Adder	78
	V23-7216-SF	72"H X 37"W X 16"D Initial	121
	V21-7216A-SF	72"H X 36"W X 16"D Adder	95

72" High single sided shelving has a wood top and four adjustable shelves.
Includes 1/4" matching wood back.

84" High	Model Number	Description	Wt.
	V23-8408	84"H X 37"W X 8"D Initial	79
	V21-8408A	84"H X 36"W X 8"D Adder	66
	V23-8410	84"H X 37"W X 10"D Initial	92
	V21-8410A	84"H X 36"W X 10"D Adder	76
	V23-8412	84"H X 37"W X 12"D Initial	106
	V21-8412A	84"H X 36"W X 12"D Adder	87
	V23-8416-SF	84"H X 37"W X 16"D Initial	133
	V21-8416A-SF	84"H X 36"W X 16"D Adder	107

84" High single sided shelving has an inverted wood cornice top and ten adjustable shelves.
Includes 1/4" matching wood back.

90" High	Model Number	Description	Wt.
	V23-9012	90"H X 37"W X 12"D Initial	115
	V21-9012A	90"H X 36"W X 12"D Adder	95

90" High single sided shelving has an inverted wood cornice top and twelve adjustable shelves.
Includes 1/4" matching wood back.

Double Faced Standard Units

30" High	Model Number	Description	Wt.
	V23-3020	30"H X 37"W X 20"D Initial	79
	V21-3020A	30"H X 36"W X 20"D Adder	68
	V23-3024	30"H X 37"W X 24"D Initial	90
	V21-3024A	30"H X 36"W X 24"D Adder	76

30" High double sided shelving has a wood top and two adjustable shelves.
Includes 1/4" matching wood back.

30" High Mobile Units	Model Number	Description	Wt.
	V23-3020-MOB	30"H X 37"W X 20"D Mobile	91
	V23-3024-MOB	30"H X 37"W X 24"D Mobile	102

36" High	Model Number	Description	Wt.
	V23-3620	36"H X 37"W X 20"D Initial	90
	V21-3620A	36"H X 36"W X 20"D Adder	76
	V23-3624	36"H X 37"W X 24"D Initial	103
	V21-3624A	36"H X 36"W X 24"D Adder	86

36" High double sided shelving has a wood top and two adjustable shelves.
Includes 1/4" matching wood back.

* Steel shelves may be specified for most wood bookcases.
Replace "V" in the model with "SB" (i.e. SB21-4220).



Double Face Standard Units Cont.

36" High Mobile Units	Model Number	Description	Wt.
	V23-3620-MOB	36"H X 37"W X 20"D Mobile	102
	V23-3624-MOB	36"H X 37"W X 24"D Mobile	115

42" High	Model Number	Description	Wt.
	V23-4220	42"H X 37"W X 20"D Initial	100
	V21-4220A	42"H X 36"W X 20"D Adder	84
	V23-4224	42"H X 37"W X 24"D Initial	115
	V21-4224A	42"H X 36"W X 24"D Adder	96

42" High double sided shelving has a wood top and four adjustable shelves. Includes 1/4" matching wood back.

42" High Mobile Units	Model Number	Description	Wt.
	V23-4220-MOB	42"H X 37"W X 20"D Mobile	112
	V23-4224-MOB	42"H X 37"W X 24"D Mobile	127

48" High	Model Number	Description	Wt.
	V23-4820	48"H X 37"W X 20"D Initial	105
	V21-4820A	48"H X 36"W X 20"D Adder	86
	V23-4824	48"H X 37"W X 24"D Initial	121
	V21-4824A	48"H X 36"W X 24"D Adder	99

48" High double sided shelving has a wood top and four adjustable shelves. Includes 1/4" matching wood back.

48" High Mobile Units	Model Number	Description	Wt.
	V23-4820-MOB	48"H X 37"W X 20"D Mobile	117
	V23-4824-MOB	48"H X 37"W X 24"D Mobile	133

60" High	Model Number	Description	Wt.
	V23-6020	60"H X 37"W X 20"D Initial	125
	V21-6020A	60"H X 36"W X 20"D Adder	102
	V23-6024	60"H X 37"W X 24"D Initial	144
	V21-6024A	60"H X 36"W X 24"D Adder	117

60" High double sided shelving has a wood top and six adjustable shelves. Includes 1/4" matching wood back.

72" High	Model Number	Description	Wt.
	V23-7220	72"H X 37"W X 20"D Initial	151
	V21-7220A	72"H X 36"W X 20"D Adder	119
	V23-7224	72"H X 37"W X 24"D Initial	176
	V21-7224A	72"H X 36"W X 24"D Adder	138

72" High double sided shelving has a wood top and eight adjustable shelves. Includes 1/4" matching wood back.

84" High	Model Number	Description	Wt.
	V23-8420	84"H X 37"W X 20"D Initial	167
	V21-8420A	84"H X 36"W X 20"D Adder	135
	V23-8424	84"H X 37"W X 24"D Initial	194
	V21-8424A	84"H X 36"W X 24"D Adder	156

84" High double sided shelving has an inverted wood cornice top and ten adjustable shelves. Includes 1/4" matching wood back.

90" High	Model Number	Description	Wt.
	V23-9024	90"H X 37"W X 24"D Initial	212
	V21-9024A	90"H X 36"W X 24"D Adder	172

90" High double sided shelving has an inverted wood cornice top and twelve adjustable shelves. Includes 1/4" matching wood back.

Single Faced Picture Book Units

42" High	Model Number	Description	Wt.
	V23-4212P	42"H X 37"W X 12"D Picture Book Initial	72
	V21-4212PA	42"H X 36"W X 12"D Picture Book Adder	63

42" High single sided shelving has a wood top, one adjustable picture book shelf and one base picture book shelf. Includes 1/4" matching wood back.

48" High	Model Number	Description	Wt.
	V23-4812P	48"H X 37"W X 12"D Picture Book Initial	75
	V21-4812PA	48"H X 36"W X 12"D Picture Book Adder	64

48" High single sided shelving has a wood top, one adjustable picture book shelf and one base picture book shelf. Includes 1/4" matching wood back.

60" High	Model Number	Description	Wt.
	V23-6012P	60"H X 37"W X 12"D Picture Book Initial	94
	V21-6012PA	60"H X 36"W X 12"D Picture Book Adder	80

60" High single sided shelving has a wood top, two adjustable picture book shelves and one base picture book shelf. Includes 1/4" matching wood back.

Double Faced Picture Book Units

42" High	Model Number	Description	Wt.
	V23-4224P	42"H X 37"W X 24"D Picture Book Initial	134
	V21-4224PA	42"H X 36"W X 24"D Picture Book Adder	115

42" High double sided shelving has a wood top, two adjustable picture book shelf and one base picture book shelf per side. Includes 1/4" matching wood back.

42" High Mobile Unit	Model Number	Description	Wt.
	V23-4224P-MOB	42"H X 37"W X 24"D Picture Book Mobile	146

48" High	Model Number	Description	Wt.
	V23-4824P	48"H X 37"W X 24"D Picture Book Initial	140
	V21-4824PA	48"H X 36"W X 24"D Picture Book Adder	118

48" High Mobile Unit	Model Number	Description	Wt.
	V23-4824P-MOB	48"H X 37"W X 24"D Picture Book Mobile	152

48" High double sided shelving has a wood top, two adjustable picture book shelf and one base picture book shelf. Includes 1/4" matching wood back.

60" High	Model Number	Description	Wt.
	V23-6024P	60"H X 37"W X 24"D Picture Book Initial	174
	V21-6024PA	60"H X 36"W X 24"D Picture Book Adder	147

60" High double sided shelving has a wood top, four adjustable picture book shelves and one base picture book shelf. Includes 1/4" matching wood back.

Options

Options	How to Indicate
Steel Shelving	Add "SB" to part number (SB21-3012) for standard steel shelves, "S" (S21-3012) for flat steel shelves



Required Item: Bookstacks

Additional Lines: Heritage



V29-4224

Heritage

*Adder vertical panels are undecorated

Single Faced Standard Units

30" High	Model Number	Description	Wt.
	V29-3008	30"H X 37"W X 8"D Initial	38
	V21-3008A	30"H X 36"W X 8"D Adder	33
	V29-3010	30"H X 37"W X 10"D Initial	43
	V21-3010A	30"H X 36"W X 10"D Adder	37
	V29-3012	30"H X 37"W X 12"D Initial	49
	V21-3012A	30"H X 36"W X 12"D Adder	42

30" High single sided shelving has a select wood top and one adjustable shelf. Includes 1/4" matching wood back.

36" High	Model Number	Description	Wt.
	V29-3608	36"H X 37"W X 8"D Initial	43
	V21-3608A	36"H X 36"W X 8"D Adder	37
	V29-3610	36"H X 37"W X 10"D Initial	49
	V21-3610A	36"H X 36"W X 10"D Adder	42
	V29-3612	36"H X 37"W X 12"D Initial	56
	V21-3612A	36"H X 36"W X 12"D Adder	48

36" High single sided shelving has a select wood top and one adjustable shelf. Includes 1/4" matching wood back.

42" High	Model Number	Description	Wt.
	V29-4208	42"H X 37"W X 8"D Initial	47
	V21-4208A	42"H X 36"W X 8"D Adder	41
	V29-4210	42"H X 37"W X 10"D Initial	55
	V21-4210A	42"H X 36"W X 10"D Adder	47
	V29-4212	42"H X 37"W X 12"D Initial	62
	V21-4212A	42"H X 36"W X 12"D Adder	53
	V29-4216-SF	42"H X 37"W X 16"D Initial	77
	V21-4216A-SF	42"H X 36"W X 16"D Adder	64

42" High single sided shelving has a wood top and two adjustable shelves. Includes 1/4" matching wood back.

48" High	Model Number	Description	Wt.
	V29-4808	48"H X 37"W X 8"D Initial	50
	V21-4808A	48"H X 36"W X 8"D Adder	43
	V29-4810	48"H X 37"W X 10"D Initial	59
	V21-4810A	48"H X 36"W X 10"D Adder	49
	V29-4812	48"H X 37"W X 12"D Initial	66
	V21-4812A	48"H X 36"W X 12"D Adder	56
	V29-4816-SF	48"H X 37"W X 16"D Initial	82
	V21-4816A-SF	48"H X 36"W X 16"D Adder	67

48" High single sided shelving has a wood top and two adjustable shelves. Includes 1/4" matching wood back.

60" High	Model Number	Description	Wt.
	V29-6008	60"H X 37"W X 8"D Initial	59
	V21-6008A	60"H X 36"W X 8"D Adder	50
	V29-6010	60"H X 37"W X 10"D Initial	69
	V21-6010A	60"H X 36"W X 10"D Adder	58
	V29-6012	60"H X 37"W X 12"D Initial	79
	V21-6012A	60"H X 36"W X 12"D Adder	65
	V29-6016-SF	60"H X 37"W X 16"D Initial	98
	V21-6016A-SF	60"H X 36"W X 16"D Adder	80

60" High single sided shelving has a wood top and three adjustable shelves. Includes 1/4" matching wood back.

72" High	Model Number	Description	Wt.
	V29-7208	72"H X 37"W X 8"D Initial	72
	V21-7208A	72"H X 36"W X 8"D Adder	59
	V29-7210	72"H X 37"W X 10"D Initial	84
	V21-7210A	72"H X 36"W X 10"D Adder	68
	V29-7212	72"H X 37"W X 12"D Initial	98
	V29-7212A	72"H X 37"W X 12"D Adder	78
	V29-7216-SF	72"H X 37"W X 16"D Initial	121
	V21-7216A-SF	72"H X 36"W X 16"D Adder	95

72" High single sided shelving has a wood top and four adjustable shelves. Includes 1/4" matching wood back.

84" High	Model Number	Description	Wt.
	V29-8408	84"H X 37"W X 8"D Initial	79
	V21-8408A	84"H X 36"W X 8"D Adder	66
	V29-8410	84"H X 37"W X 10"D Initial	92
	V21-8410A	84"H X 36"W X 10"D Adder	76
	V29-8412	84"H X 37"W X 12"D Initial	106
	V21-8412A	84"H X 36"W X 12"D Adder	87
	V29-8416-SF	84"H X 37"W X 16"D Initial	133
	V21-8416A-SF	84"H X 36"W X 16"D Adder	107

84" High single sided shelving has an inverted wood cornice top and ten adjustable shelves. Includes 1/4" matching wood back.

90" High	Model Number	Description	Wt.
	V29-9012	90"H X 37"W X 12"D Initial	115
	V21-9012A	90"H X 36"W X 12"D Adder	95

90" High single sided shelving has an inverted wood cornice top and twelve adjustable shelves. Includes 1/4" matching wood back.

Double Faced Standard Units

30" High	Model Number	Description	Wt.
	V29-3020	30"H X 37"W X 20"D Initial	79
	V21-3020A	30"H X 36"W X 20"D Adder	68
	V29-3024	30"H X 37"W X 24"D Initial	90
	V21-3024A	30"H X 36"W X 24"D Adder	76

30" High double sided shelving has a wood top and two adjustable shelves. Includes 1/4" matching wood back.

30" High	Model Number	Description	Wt.
	V29-3020-MOB	30"H X 37"W X 20"D Mobile	91
	V29-3024-MOB	30"H X 37"W X 24"D Mobile	102

36" High	Model Number	Description	Wt.
	V29-3620	36"H X 37"W X 20"D Initial	90
	V21-3620A	36"H X 36"W X 20"D Adder	76
	V29-3624	36"H X 37"W X 24"D Initial	103
	V21-3624A	36"H X 36"W X 24"D Adder	86

36" High double sided shelving has a wood top and two adjustable shelves. Includes 1/4" matching wood back.

* Steel shelves may be specified for most wood bookcases. Replace "V" in the model with "SB" (i.e. SB21-4220).

Double Face Standard Units Cont.

36" High	Model Number	Description	Wt.
	V29-3620-MOB	36"H X 37"W X 20"D Mobile	102
	V29-3624-MOB	36"H X 37"W X 24"D Mobile	115

42" High	Model Number	Description	Wt.
	V29-4220	42"H X 37"W X 20"D Initial	100
	V21-4220A	42"H X 36"W X 20"D Adder	84
	V29-4224	42"H X 37"W X 24"D Initial	115
	V21-4224A	42"H X 36"W X 24"D Adder	96

42" High double sided shelving has a wood top and four adjustable shelves. Includes 1/4" matching wood back.

42" High Mobile Units	Model Number	Description	Wt.
	V29-4220-MOB	42"H X 37"W X 20"D Mobile	112
	V29-4224-MOB	42"H X 37"W X 24"D Mobile	127

48" High	Model Number	Description	Wt.
	V29-4820	48"H X 37"W X 20"D Initial	105
	V21-4820A	48"H X 36"W X 20"D Adder	86
	V29-4824	48"H X 37"W X 24"D Initial	121
	V21-4824A	48"H X 36"W X 24"D Adder	99

48" High double sided shelving has a wood top and four adjustable shelves. Includes 1/4" matching wood back.

48" High Mobile Units	Model Number	Description	Wt.
	V29-4820-MOB	48"H X 37"W X 20"D Mobile	117
	V29-4824-MOB	48"H X 37"W X 24"D Mobile	133

60" High	Model Number	Description	Wt.
	V29-6020	60"H X 37"W X 20"D Initial	125
	V21-6020A	60"H X 36"W X 20"D Adder	102
	V29-6024	60"H X 37"W X 24"D Initial	144
	V21-6024A	60"H X 36"W X 24"D Adder	117

60" High double sided shelving has a wood top and six adjustable shelves. Includes 1/4" matching wood back.

72" High	Model Number	Description	Wt.
	V29-7220	72"H X 37"W X 20"D Initial	151
	V21-7220A	72"H X 36"W X 20"D Adder	119
	V29-7224	72"H X 37"W X 24"D Initial	176
	V21-7224A	72"H X 36"W X 24"D Adder	138

72" High double sided shelving has a wood top and eight adjustable shelves. Includes 1/4" matching wood back.

84" High	Model Number	Description	Wt.
	V29-8420	84"H X 37"W X 20"D Initial	167
	V21-8420A	84"H X 36"W X 20"D Adder	135
	V29-8424	84"H X 37"W X 24"D Initial	194
	V21-8424A	84"H X 36"W X 24"D Adder	156

84" High double sided shelving has an inverted wood cornice top and ten adjustable shelves. Includes 1/4" matching wood back.

90" High	Model Number	Description	Wt.
	V29-9024	90"H X 37"W X 24"D Initial	212
	V21-9024A	90"H X 36"W X 24"D Adder	172

90" High double sided shelving has an inverted wood cornice top and twelve adjustable shelves. Includes 1/4" matching wood back.

Single Faced Picture Book Units

42" High	Model Number	Description	Wt.
	V29-4212P	42"H X 37"W X 12"D Picture Book Initial	72
	V21-4212PA	42"H X 36"W X 12"D Picture Book Adder	63

42" High single sided shelving has a wood top, one adjustable picture book shelf and one base picture book shelf. Includes 1/4" matching wood back.

48" High	Model Number	Description	Wt.
	V29-4812P	48"H X 37"W X 12"D Picture Book Initial	75
	V21-4812PA	48"H X 36"W X 12"D Picture Book Adder	64

48" High single sided shelving has a wood top, one adjustable picture book shelf and one base picture book shelf. Includes 1/4" matching wood back.

60" High	Model Number	Description	Wt.
	V29-6012P	60"H X 37"W X 12"D Picture Book Initial	94
	V21-6012PA	60"H X 36"W X 12"D Picture Book Adder	80

60" High single sided shelving has a wood top, two adjustable picture book shelves and one base picture book shelf. Includes 1/4" matching wood back.

Double Faced Picture Book Units

42" High	Model Number	Description	Wt.
	V29-4224P	42"H X 37"W X 24"D Picture Book Initial	134
	V21-4224PA	42"H X 36"W X 24"D Picture Book Adder	115

42" High double sided shelving has a wood top, two adjustable picture book shelf and one base picture book shelf per side. Includes 1/4" matching wood back.

42" High Mobile Unit	Model Number	Description	Wt.
	V29-4224P-MOB	42"H X 37"W X 24"D Picture Book Mobile	146

48" High	Model Number	Description	Wt.
	V29-4824P	48"H X 37"W X 24"D Picture Book Initial	140
	V21-4824PA	48"H X 36"W X 24"D Picture Book Adder	118

48" High double sided shelving has a wood top, two adjustable picture book shelf and one base picture book shelf. Includes 1/4" matching wood back.

48" High Mobile Unit	Model Number	Description	Wt.
	V29-4824P-MOB	48"H X 37"W X 24"D Picture Book Mobile	152

60" High	Model Number	Description	Wt.
	V29-6024P	60"H X 37"W X 24"D Picture Book Initial	174
	V21-6024PA	60"H X 36"W X 24"D Picture Book Adder	147

60" High double sided shelving has a wood top, four adjustable picture book shelves and one base picture book shelf. Includes 1/4" matching wood back.

Options

Options	How to Indicate
Steel Shelving	Add "SB" to part number (SB21-3012) for standard steel shelves, "S" (S21-3012) for flat steel shelves

Required Item: Bookstacks

Additional Lines: Charleston



V28-4224

Charleston

*Adder vertical panels are undecorated

Single Faced Standard Units

30" High	Model Number	Description	Wt.
	V28-3008	30"H X 37"W X 8"D Initial	38
	V21-3008A	30"H X 36"W X 8"D Adder	33
	V28-3010	30"H X 37"W X 10"D Initial	43
	V21-3010A	30"H X 36"W X 10"D Adder	37
	V28-3012	30"H X 37"W X 12"D Initial	49
	V21-3012A	30"H X 36"W X 12"D Adder	42

30" High single sided shelving has a select wood top and one adjustable shelf. Includes 1/4" matching wood back.

36" High	Model Number	Description	Wt.
	V28-3608	36"H X 37"W X 8"D Initial	43
	V21-3608A	36"H X 36"W X 8"D Adder	37
	V28-3610	36"H X 37"W X 10"D Initial	49
	V21-3610A	36"H X 36"W X 10"D Adder	42
	V28-3612	36"H X 37"W X 12"D Initial	56
	V21-3612A	36"H X 36"W X 12"D Adder	48

36" High single sided shelving has a select wood top and one adjustable shelf. Includes 1/4" matching wood back.

42" High	Model Number	Description	Wt.
	V28-4208	42"H X 37"W X 8"D Initial	47
	V21-4208A	42"H X 36"W X 8"D Adder	41
	V28-4210	42"H X 37"W X 10"D Initial	55
	V21-4210A	42"H X 36"W X 10"D Adder	47
	V28-4212	42"H X 37"W X 12"D Initial	62
	V21-4212A	42"H X 36"W X 12"D Adder	53
	V28-4216-SF	42"H X 37"W X 16"D Initial	77
	V21-4216A-SF	42"H X 36"W X 16"D Adder	64

42" High single sided shelving has a wood top and two adjustable shelves. Includes 1/4" matching wood back.

48" High	Model Number	Description	Wt.
	V28-4808	48"H X 37"W X 8"D Initial	50
	V21-4808A	48"H X 36"W X 8"D Adder	43
	V28-4810	48"H X 37"W X 10"D Initial	59
	V21-4810A	48"H X 36"W X 10"D Adder	49
	V28-4812	48"H X 37"W X 12"D Initial	66
	V21-4812A	48"H X 36"W X 12"D Adder	56
	V28-4816-SF	48"H X 37"W X 16"D Initial	82
	V21-4816A-SF	48"H X 36"W X 16"D Adder	67

48" High single sided shelving has a wood top and two adjustable shelves. Includes 1/4" matching wood back.

60" High	Model Number	Description	Wt.
	V28-6008	60"H X 37"W X 8"D Initial	59
	V21-6008A	60"H X 36"W X 8"D Adder	50
	V28-6010	60"H X 37"W X 10"D Initial	69
	V21-6010A	60"H X 36"W X 10"D Adder	58
	V28-6012	60"H X 37"W X 12"D Initial	79
	V21-6012A	60"H X 36"W X 12"D Adder	65
	V28-6016-SF	60"H X 37"W X 16"D Initial	98
	V21-6016A-SF	60"H X 36"W X 16"D Adder	80

60" High single sided shelving has a wood top and three adjustable shelves. Includes 1/4" matching wood back.

72" High	Model Number	Description	Wt.
	V28-7208	72"H X 37"W X 8"D Initial	72
	V21-7208A	72"H X 36"W X 8"D Adder	59
	V28-7210	72"H X 37"W X 10"D Initial	84
	V21-7210A	72"H X 36"W X 10"D Adder	68
	V28-7212	72"H X 37"W X 12"D Initial	98
	V28-7212A	72"H X 37"W X 12"D Adder	78
	V28-7216-SF	72"H X 37"W X 16"D Initial	121
	V21-7216A-SF	72"H X 36"W X 16"D Adder	95

72" High single sided shelving has a wood top and four adjustable shelves. Includes 1/4" matching wood back.

84" High	Model Number	Description	Wt.
	V28-8408	84"H X 37"W X 8"D Initial	79
	V21-8408A	84"H X 36"W X 8"D Adder	66
	V28-8410	84"H X 37"W X 10"D Initial	92
	V21-8410A	84"H X 36"W X 10"D Adder	76
	V28-8412	84"H X 37"W X 12"D Initial	106
	V21-8412A	84"H X 36"W X 12"D Adder	87
	V28-8416-SF	84"H X 37"W X 16"D Initial	133
	V21-8416A-SF	84"H X 36"W X 16"D Adder	107

84" High single sided shelving has an inverted wood cornice top and ten adjustable shelves. Includes 1/4" matching wood back.

90" High	Model Number	Description	Wt.
	V28-9012	90"H X 37"W X 12"D Initial	115
	V21-9012A	90"H X 36"W X 12"D Adder	95

90" High single sided shelving has an inverted wood cornice top and twelve adjustable shelves. Includes 1/4" matching wood back.

Double Faced Standard Units

30" High	Model Number	Description	Wt.
	V28-3020	30"H X 37"W X 20"D Initial	79
	V21-3020A	30"H X 36"W X 20"D Adder	68
	V28-3024	30"H X 37"W X 24"D Initial	90
	V21-3024A	30"H X 36"W X 24"D Adder	76

30" High double sided shelving has a wood top and two adjustable shelves. Includes 1/4" matching wood back.

30" High Mobile Units	Model Number	Description	Wt.
	V28-3020-MOB	30"H X 37"W X 20"D Mobile	91
	V28-3024-MOB	30"H X 37"W X 24"D Mobile	102

36" High	Model Number	Description	Wt.
	V28-3620	36"H X 37"W X 20"D Initial	90
	V21-3620A	36"H X 36"W X 20"D Adder	76
	V28-3624	36"H X 37"W X 24"D Initial	103
	V21-3624A	36"H X 36"W X 24"D Adder	86

36" High double sided shelving has a wood top and two adjustable shelves. Includes 1/4" matching wood back.

* Steel shelves may be specified for most wood bookcases. Replace "V" in the model with "SB" (i.e. SB21-4220).



Double Face Standard Units Cont.

36" High Mobile Units	Model Number	Description	Wt.
	V28-3620-MOB	36"H X 37"W X 20"D Mobile	102
	V28-3624-MOB	36"H X 37"W X 24"D Mobile	115

42" High	Model Number	Description	Wt.
	V28-4220	42"H X 37"W X 20"D Initial	100
	V21-4220A	42"H X 36"W X 20"D Adder	84
	V28-4224	42"H X 37"W X 24"D Initial	115
	V21-4224A	42"H X 36"W X 24"D Adder	96

42" High double sided shelving has a wood top and four adjustable shelves. Includes 1/4" matching wood back.

42" High Mobile Units	Model Number	Description	Wt.
	V28-4220-MOB	42"H X 37"W X 20"D Mobile	112
	V28-4224-MOB	42"H X 37"W X 24"D Mobile	127

48" High	Model Number	Description	Wt.
	V28-4820	48"H X 37"W X 20"D Initial	105
	V21-4820A	48"H X 36"W X 20"D Adder	86
	V28-4824	48"H X 37"W X 24"D Initial	121
	V21-4824A	48"H X 36"W X 24"D Adder	99

48" High double sided shelving has a wood top and four adjustable shelves. Includes 1/4" matching wood back.

48" High Mobile Units	Model Number	Description	Wt.
	V28-4820-MOB	48"H X 37"W X 20"D Mobile	117
	V28-4824-MOB	48"H X 37"W X 24"D Mobile	133

60" High	Model Number	Description	Wt.
	V28-6020	60"H X 37"W X 20"D Initial	125
	V21-6020A	60"H X 36"W X 20"D Adder	102
	V28-6024	60"H X 37"W X 24"D Initial	144
	V21-6024A	60"H X 36"W X 24"D Adder	117

60" High double sided shelving has a wood top and six adjustable shelves. Includes 1/4" matching wood back.

72" High	Model Number	Description	Wt.
	V28-7220	72"H X 37"W X 20"D Initial	151
	V21-7220A	72"H X 36"W X 20"D Adder	119
	V28-7224	72"H X 37"W X 24"D Initial	176
	V21-7224A	72"H X 36"W X 24"D Adder	138

72" High double sided shelving has a wood top and eight adjustable shelves. Includes 1/4" matching wood back.

84" High	Model Number	Description	Wt.
	V28-8420	84"H X 37"W X 20"D Initial	167
	V21-8420A	84"H X 36"W X 20"D Adder	135
	V28-8424	84"H X 37"W X 24"D Initial	194
	V21-8424A	84"H X 36"W X 24"D Adder	156

84" High double sided shelving has an inverted wood cornice top and ten adjustable shelves. Includes 1/4" matching wood back.

90" High	Model Number	Description	Wt.
	V28-9024	90"H X 37"W X 24"D Initial	212
	V21-9024A	90"H X 36"W X 24"D Adder	172

90" High double sided shelving has an inverted wood cornice top and twelve adjustable shelves. Includes 1/4" matching wood back.

Single Faced Picture Book Units

42" High	Model Number	Description	Wt.
	V28-4212P	42"H X 37"W X 12"D Picture Book Initial	72
	V21-4212PA	42"H X 36"W X 12"D Picture Book Adder	63

42" High single sided shelving has a wood top, one adjustable picture book shelf and one base picture book shelf. Includes 1/4" matching wood back.

48" High	Model Number	Description	Wt.
	V28-4812P	48"H X 37"W X 12"D Picture Book Initial	75
	V21-4812PA	48"H X 36"W X 12"D Picture Book Adder	64

48" High single sided shelving has a wood top, one adjustable picture book shelf and one base picture book shelf. Includes 1/4" matching wood back.

60" High	Model Number	Description	Wt.
	V28-6012P	60"H X 37"W X 12"D Picture Book Initial	94
	V21-6012PA	60"H X 36"W X 12"D Picture Book Adder	80

60" High single sided shelving has a wood top, two adjustable picture book shelves and one base picture book shelf. Includes 1/4" matching wood back.

Double Faced Picture Book Units

42" High	Model Number	Description	Wt.
	V28-4224P	42"H X 37"W X 24"D Picture Book Initial	134
	V21-4224PA	42"H X 36"W X 24"D Picture Book Adder	115

42" High double sided shelving has a wood top, two adjustable picture book shelf and one base picture book shelf per side. Includes 1/4" matching wood back.

42" High Mobile Unit	Model Number	Description	Wt.
	V28-4224P-MOB	42"H X 37"W X 24"D Picture Book Mobile	146

48" High	Model Number	Description	Wt.
	V28-4824P	48"H X 37"W X 24"D Picture Book Initial	140
	V21-4824PA	48"H X 36"W X 24"D Picture Book Adder	118

48" High double sided shelving has a wood top, two adjustable picture book shelf and one base picture book shelf. Includes 1/4" matching wood back.

48" High Mobile Unit	Model Number	Description	Wt.
	V28-4824P-MOB	48"H X 37"W X 24"D Picture Book Mobile	152

60" High	Model Number	Description	Wt.
	V28-6024P	60"H X 37"W X 24"D Picture Book Initial	174
	V21-6024PA	60"H X 36"W X 24"D Picture Book Adder	147

60" High double sided shelving has a wood top, four adjustable picture book shelves and one base picture book shelf. Includes 1/4" matching wood back.

Options

Options	How to Indicate
Steel Shelving	Add "SB" to part number (SB21-3012) for standard steel shelves, "S" (S21-3012) for flat steel shelves



Required Item: Bookstacks

Additional Lines: Malibu



Malibu

*Adder vertical panels are undecorated

V22-4224

Single Faced Standard Units

30" High	Model Number	Description	Wt.
	V22-3008	30"H X 37"W X 8"D Initial	38
	V21-3008A	30"H X 36"W X 8"D Adder	33
	V22-3010	30"H X 37"W X 10"D Initial	43
	V21-3010A	30"H X 36"W X 10"D Adder	37
	V22-3012	30"H X 37"W X 12"D Initial	49
	V21-3012A	30"H X 36"W X 12"D Adder	42

30" High single sided shelving has a select wood top and one adjustable shelf. Includes 1/4" matching wood back.

36" High	Model Number	Description	Wt.
	V22-3608	36"H X 37"W X 8"D Initial	43
	V21-3608A	36"H X 36"W X 8"D Adder	37
	V22-3610	36"H X 37"W X 10"D Initial	49
	V21-3610A	36"H X 36"W X 10"D Adder	42
	V22-3612	36"H X 37"W X 12"D Initial	56
	V21-3612A	36"H X 36"W X 12"D Adder	48

36" High single sided shelving has a select wood top and one adjustable shelf. Includes 1/4" matching wood back.

42" High	Model Number	Description	Wt.
	V22-4208	42"H X 37"W X 8"D Initial	47
	V21-4208A	42"H X 36"W X 8"D Adder	41
	V22-4210	42"H X 37"W X 10"D Initial	55
	V21-4210A	42"H X 36"W X 10"D Adder	47
	V22-4212	42"H X 37"W X 12"D Initial	62
	V21-4212A	42"H X 36"W X 12"D Adder	53
	V22-4216-SF	42"H X 37"W X 16"D Initial	77
	V21-4216A-SF	42"H X 36"W X 16"D Adder	64

42" High single sided shelving has a wood top and two adjustable shelves. Includes 1/4" matching wood back.

48" High	Model Number	Description	Wt.
	V22-4808	48"H X 37"W X 8"D Initial	50
	V21-4808A	48"H X 36"W X 8"D Adder	43
	V22-4810	48"H X 37"W X 10"D Initial	59
	V21-4810A	48"H X 36"W X 10"D Adder	49
	V22-4812	48"H X 37"W X 12"D Initial	66
	V21-4812A	48"H X 36"W X 12"D Adder	56
	V22-4816-SF	48"H X 37"W X 16"D Initial	82
	V21-4816A-SF	48"H X 36"W X 16"D Adder	67

48" High single sided shelving has a wood top and two adjustable shelves. Includes 1/4" matching wood back.

60" High	Model Number	Description	Wt.
	V22-6008	60"H X 37"W X 8"D Initial	59
	V21-6008A	60"H X 36"W X 8"D Adder	50
	V22-6010	60"H X 37"W X 10"D Initial	69
	V21-6010A	60"H X 36"W X 10"D Adder	58
	V22-6012	60"H X 37"W X 12"D Initial	79
	V21-6012A	60"H X 36"W X 12"D Adder	65
	V22-6016-SF	60"H X 37"W X 16"D Initial	98
	V21-6016A-SF	60"H X 36"W X 16"D Adder	80

60" High single sided shelving has a wood top and three adjustable shelves. Includes 1/4" matching wood back.

72" High	Model Number	Description	Wt.
	V22-7208	72"H X 37"W X 8"D Initial	72
	V21-7208A	72"H X 36"W X 8"D Adder	59
	V22-7210	72"H X 37"W X 10"D Initial	84
	V21-7210A	72"H X 36"W X 10"D Adder	68
	V22-7212	72"H X 37"W X 12"D Initial	98
	V22-7212A	72"H X 37"W X 12"D Adder	78
	V22-7216-SF	72"H X 37"W X 16"D Initial	121
	V21-7216A-SF	72"H X 36"W X 16"D Adder	95

72" High single sided shelving has a wood top and four adjustable shelves. Includes 1/4" matching wood back.

84" High	Model Number	Description	Wt.
	V22-8408	84"H X 37"W X 8"D Initial	79
	V21-8408A	84"H X 36"W X 8"D Adder	66
	V22-8410	84"H X 37"W X 10"D Initial	92
	V21-8410A	84"H X 36"W X 10"D Adder	76
	V22-8412	84"H X 37"W X 12"D Initial	106
	V21-8412A	84"H X 36"W X 12"D Adder	87
	V22-8416-SF	84"H X 37"W X 16"D Initial	133
	V21-8416A-SF	84"H X 36"W X 16"D Adder	107

84" High single sided shelving has an inverted wood cornice top and ten adjustable shelves. Includes 1/4" matching wood back.

90" High	Model Number	Description	Wt.
	V22-9012	90"H X 37"W X 12"D Initial	115
	V21-9012A	90"H X 36"W X 12"D Adder	95

90" High single sided shelving has an inverted wood cornice top and twelve adjustable shelves. Includes 1/4" matching wood back.

Double Faced Standard Units

30" High	Model Number	Description	Wt.
	V22-3020	30"H X 37"W X 20"D Initial	79
	V21-3020A	30"H X 36"W X 20"D Adder	68
	V22-3024	30"H X 37"W X 24"D Initial	90
	V21-3024A	30"H X 36"W X 24"D Adder	76

30" High double sided shelving has a wood top and two adjustable shelves. Includes 1/4" matching wood back.

30" High Mobile Units	Model Number	Description	Wt.
	V22-3020-MOB	30"H X 37"W X 20"D Mobile	91
	V22-3024-MOB	30"H X 37"W X 24"D Mobile	102

36" High	Model Number	Description	Wt.
	V22-3620	36"H X 37"W X 20"D Initial	90
	V21-3620A	36"H X 36"W X 20"D Adder	76
	V22-3624	36"H X 37"W X 24"D Initial	103
	V21-3624A	36"H X 36"W X 24"D Adder	86

36" High double sided shelving has a wood top and two adjustable shelves. Includes 1/4" matching wood back.

* Steel shelves may be specified for most wood bookcases. Replace "V" in the model with "SB" (i.e. SB21-4220).



Double Face Standard Units Cont.

36" High Mobile Units	Model Number	Description	Wt.
	V22-3620-MOB	36"H X 37"W X 20"D Mobile	102
	V22-3624-MOB	36"H X 37"W X 24"D Mobile	115

42" High	Model Number	Description	Wt.
	V22-4220	42"H X 37"W X 20"D Initial	100
	V21-4220A	42"H X 36"W X 20"D Adder	84
	V22-4224	42"H X 37"W X 24"D Initial	115
	V21-4224A	42"H X 36"W X 24"D Adder	96

42" High double sided shelving has a wood top and four adjustable shelves. Includes 1/4" matching wood back.

42" High Mobile Units	Model Number	Description	Wt.
	V22-4220-MOB	42"H X 37"W X 20"D Mobile	112
	V22-4224-MOB	42"H X 37"W X 24"D Mobile	127

48" High	Model Number	Description	Wt.
	V22-4820	48"H X 37"W X 20"D Initial	105
	V21-4820A	48"H X 36"W X 20"D Adder	86
	V22-4824	48"H X 37"W X 24"D Initial	121
	V21-4824A	48"H X 36"W X 24"D Adder	99

48" High double sided shelving has a wood top and four adjustable shelves. Includes 1/4" matching wood back.

48" High Mobile Units	Model Number	Description	Wt.
	V22-4820-MOB	48"H X 37"W X 20"D Mobile	117
	V22-4824-MOB	48"H X 37"W X 24"D Mobile	133

60" High	Model Number	Description	Wt.
	V22-6020	60"H X 37"W X 20"D Initial	125
	V21-6020A	60"H X 36"W X 20"D Adder	102
	V22-6024	60"H X 37"W X 24"D Initial	144
	V21-6024A	60"H X 36"W X 24"D Adder	117

60" High double sided shelving has a wood top and six adjustable shelves. Includes 1/4" matching wood back.

72" High	Model Number	Description	Wt.
	V22-7220	72"H X 37"W X 20"D Initial	151
	V21-7220A	72"H X 36"W X 20"D Adder	119
	V22-7224	72"H X 37"W X 24"D Initial	176
	V21-7224A	72"H X 36"W X 24"D Adder	138

72" High double sided shelving has a wood top and eight adjustable shelves. Includes 1/4" matching wood back.

84" High	Model Number	Description	Wt.
	V22-8420	84"H X 37"W X 20"D Initial	167
	V21-8420A	84"H X 36"W X 20"D Adder	135
	V22-8424	84"H X 37"W X 24"D Initial	194
	V21-8424A	84"H X 36"W X 24"D Adder	156

84" High double sided shelving has an inverted wood cornice top and ten adjustable shelves. Includes 1/4" matching wood back.

90" High	Model Number	Description	Wt.
	V22-9024	90"H X 37"W X 24"D Initial	212
	V21-9024A	90"H X 36"W X 24"D Adder	172

90" High double sided shelving has an inverted wood cornice top and twelve adjustable shelves. Includes 1/4" matching wood back.

Single Faced Picture Book Units

42" High	Model Number	Description	Wt.
	V22-4212P	42"H X 37"W X 12"D Picture Book Initial	72
	V21-4212PA	42"H X 36"W X 12"D Picture Book Adder	63

42" High single sided shelving has a wood top, one adjustable picture book shelf and one base picture book shelf. Includes 1/4" matching wood back.

48" High	Model Number	Description	Wt.
	V22-4812P	48"H X 37"W X 12"D Picture Book Initial	75
	V21-4812PA	48"H X 36"W X 12"D Picture Book Adder	64

48" High single sided shelving has a wood top, one adjustable picture book shelf and one base picture book shelf. Includes 1/4" matching wood back.

60" High	Model Number	Description	Wt.
	V22-6012P	60"H X 37"W X 12"D Picture Book Initial	94
	V21-6012PA	60"H X 36"W X 12"D Picture Book Adder	80

60" High single sided shelving has a wood top, two adjustable picture book shelves and one base picture book shelf. Includes 1/4" matching wood back.

Double Faced Picture Book Units

42" High	Model Number	Description	Wt.
	V22-4224P	42"H X 37"W X 24"D Picture Book Initial	134
	V21-4224PA	42"H X 36"W X 24"D Picture Book Adder	115

42" High double sided shelving has a wood top, two adjustable picture book shelf and one base picture book shelf per side. Includes 1/4" matching wood back.

42" High Mobile Unit	Model Number	Description	Wt.
	V22-4224P-MOB	42"H X 37"W X 24"D Picture Book Mobile	146

48" High	Model Number	Description	Wt.
	V22-4824P	48"H X 37"W X 24"D Picture Book Initial	140
	V21-4824PA	48"H X 36"W X 24"D Picture Book Adder	118

48" High double sided shelving has a wood top, two adjustable picture book shelf and one base picture book shelf. Includes 1/4" matching wood back.

48" High Mobile Unit	Model Number	Description	Wt.
	V22-4824P-MOB	48"H X 37"W X 24"D Picture Book Mobile	152

60" High	Model Number	Description	Wt.
	V22-6024P	60"H X 37"W X 24"D Picture Book Initial	174
	V21-6024PA	60"H X 36"W X 24"D Picture Book Adder	147

60" High double sided shelving has a wood top, four adjustable picture book shelves and one base picture book shelf. Includes 1/4" matching wood back.

Options

How to Indicate

Steel Shelving

Add "SB" to part number (SB21-3012) for standard steel shelves, "S" (S21-3012) for flat steel shelves

Required Item: Bookstacks

Additional Lines: Lexington



V27-4224

Lexington

*Adder vertical panels are undecorated

Single Faced Standard Units

30" High	Model Number	Description	Wt.
	V27-3008	30"H X 37"W X 8"D Initial	38
	V21-3008A	30"H X 36"W X 8"D Adder	33
	V27-3010	30"H X 37"W X 10"D Initial	43
	V21-3010A	30"H X 36"W X 10"D Adder	37
	V27-3012	30"H X 37"W X 12"D Initial	49
	V21-3012A	30"H X 36"W X 12"D Adder	42

30" High single sided shelving has a select wood top and one adjustable shelf. Includes 1/4" matching wood back.

36" High	Model Number	Description	Wt.
	V27-3608	36"H X 37"W X 8"D Initial	43
	V21-3608A	36"H X 36"W X 8"D Adder	37
	V27-3610	36"H X 37"W X 10"D Initial	49
	V21-3610A	36"H X 36"W X 10"D Adder	42
	V27-3612	36"H X 37"W X 12"D Initial	56
	V21-3612A	36"H X 36"W X 12"D Adder	48

36" High single sided shelving has a select wood top and one adjustable shelf. Includes 1/4" matching wood back.

42" High	Model Number	Description	Wt.
	V27-4208	42"H X 37"W X 8"D Initial	47
	V21-4208A	42"H X 36"W X 8"D Adder	41
	V27-4210	42"H X 37"W X 10"D Initial	55
	V21-4210A	42"H X 36"W X 10"D Adder	47
	V27-4212	42"H X 37"W X 12"D Initial	62
	V21-4212A	42"H X 36"W X 12"D Adder	53
	V27-4216-SF	42"H X 37"W X 16"D Initial	77
	V21-4216A-SF	42"H X 36"W X 16"D Adder	64

42" High single sided shelving has a wood top and two adjustable shelves. Includes 1/4" matching wood back.

48" High	Model Number	Description	Wt.
	V27-4808	48"H X 37"W X 8"D Initial	50
	V21-4808A	48"H X 36"W X 8"D Adder	43
	V27-4810	48"H X 37"W X 10"D Initial	59
	V21-4810A	48"H X 36"W X 10"D Adder	49
	V27-4812	48"H X 37"W X 12"D Initial	66
	V21-4812A	48"H X 36"W X 12"D Adder	56
	V27-4816-SF	48"H X 37"W X 16"D Initial	82
	V21-4816A-SF	48"H X 36"W X 16"D Adder	67

48" High single sided shelving has a wood top and two adjustable shelves. Includes 1/4" matching wood back.

60" High	Model Number	Description	Wt.
	V27-6008	60"H X 37"W X 8"D Initial	59
	V21-6008A	60"H X 36"W X 8"D Adder	50
	V27-6010	60"H X 37"W X 10"D Initial	69
	V21-6010A	60"H X 36"W X 10"D Adder	58
	V27-6012	60"H X 37"W X 12"D Initial	79
	V21-6012A	60"H X 36"W X 12"D Adder	65
	V27-6016-SF	60"H X 37"W X 16"D Initial	98
	V21-6016A-SF	60"H X 36"W X 16"D Adder	80

60" High single sided shelving has a wood top and three adjustable shelves. Includes 1/4" matching wood back.

72" High	Model Number	Description	Wt.
	V27-7208	72"H X 37"W X 8"D Initial	72
	V21-7208A	72"H X 36"W X 8"D Adder	59
	V27-7210	72"H X 37"W X 10"D Initial	84
	V21-7210A	72"H X 36"W X 10"D Adder	68
	V27-7212	72"H X 37"W X 12"D Initial	98
	V27-7212A	72"H X 37"W X 12"D Adder	78
	V27-7216-SF	72"H X 37"W X 16"D Initial	121
	V21-7216A-SF	72"H X 36"W X 16"D Adder	95

72" High single sided shelving has a wood top and four adjustable shelves. Includes 1/4" matching wood back.

84" High	Model Number	Description	Wt.
	V27-8408	84"H X 37"W X 8"D Initial	79
	V21-8408A	84"H X 36"W X 8"D Adder	66
	V27-8410	84"H X 37"W X 10"D Initial	92
	V21-8410A	84"H X 36"W X 10"D Adder	76
	V27-8412	84"H X 37"W X 12"D Initial	106
	V21-8412A	84"H X 36"W X 12"D Adder	87
	V27-8416-SF	84"H X 37"W X 16"D Initial	133
	V21-8416A-SF	84"H X 36"W X 16"D Adder	107

84" High single sided shelving has an inverted wood cornice top and ten adjustable shelves. Includes 1/4" matching wood back.

90" High	Model Number	Description	Wt.
	V27-9012	90"H X 37"W X 12"D Initial	115
	V21-9012A	90"H X 36"W X 12"D Adder	95

90" High single sided shelving has an inverted wood cornice top and twelve adjustable shelves. Includes 1/4" matching wood back.

Double Faced Standard Units

30" High	Model Number	Description	Wt.
	V27-3020	30"H X 37"W X 20"D Initial	79
	V21-3020A	30"H X 36"W X 20"D Adder	68
	V27-3024	30"H X 37"W X 24"D Initial	90
	V21-3024A	30"H X 36"W X 24"D Adder	76

30" High double sided shelving has a wood top and two adjustable shelves. Includes 1/4" matching wood back.

30" High Mobile Units	Model Number	Description	Wt.
	V27-3020-MOB	30"H X 37"W X 20"D Mobile	91
	V27-3024-MOB	30"H X 37"W X 24"D Mobile	102

36" High	Model Number	Description	Wt.
	V27-3620	36"H X 37"W X 20"D Initial	90
	V21-3620A	36"H X 36"W X 20"D Adder	76
	V27-3624	36"H X 37"W X 24"D Initial	103
	V21-3624A	36"H X 36"W X 24"D Adder	86

36" High double sided shelving has a wood top and two adjustable shelves. Includes 1/4" matching wood back.

* Steel shelves may be specified for most wood bookcases. Replace "V" in the model with "SB" (i.e. SB21-4220).



Double Face Standard Units Cont.

36" High Mobile Units	Model Number	Description	Wt.
	V27-3620-MOB	36"H X 37"W X 20"D Mobile	102
	V27-3624-MOB	36"H X 37"W X 24"D Mobile	115

42" High	Model Number	Description	Wt.
	V27-4220	42"H X 37"W X 20"D Initial	100
	V21-4220A	42"H X 36"W X 20"D Adder	84
	V27-4224	42"H X 37"W X 24"D Initial	115
	V21-4224A	42"H X 36"W X 24"D Adder	96

42" High double sided shelving has a wood top and four adjustable shelves. Includes 1/4" matching wood back.

42" High Mobile Units	Model Number	Description	Wt.
	V27-4220-MOB	42"H X 37"W X 20"D Mobile	112
	V27-4224-MOB	42"H X 37"W X 24"D Mobile	127

48" High	Model Number	Description	Wt.
	V27-4820	48"H X 37"W X 20"D Initial	105
	V21-4820A	48"H X 36"W X 20"D Adder	86
	V27-4824	48"H X 37"W X 24"D Initial	121
	V21-4824A	48"H X 36"W X 24"D Adder	99

48" High double sided shelving has a wood top and four adjustable shelves. Includes 1/4" matching wood back.

48" High Mobile Units	Model Number	Description	Wt.
	V27-4820-MOB	48"H X 37"W X 20"D Mobile	117
	V27-4824-MOB	48"H X 37"W X 24"D Mobile	133

60" High	Model Number	Description	Wt.
	V27-6020	60"H X 37"W X 20"D Initial	125
	V21-6020A	60"H X 36"W X 20"D Adder	102
	V27-6024	60"H X 37"W X 24"D Initial	144
	V21-6024A	60"H X 36"W X 24"D Adder	117

60" High double sided shelving has a wood top and six adjustable shelves. Includes 1/4" matching wood back.

72" High	Model Number	Description	Wt.
	V27-7220	72"H X 37"W X 20"D Initial	151
	V21-7220A	72"H X 36"W X 20"D Adder	119
	V27-7224	72"H X 37"W X 24"D Initial	176
	V21-7224A	72"H X 36"W X 24"D Adder	138

72" High double sided shelving has a wood top and eight adjustable shelves. Includes 1/4" matching wood back.

84" High	Model Number	Description	Wt.
	V27-8420	84"H X 37"W X 20"D Initial	167
	V21-8420A	84"H X 36"W X 20"D Adder	135
	V27-8424	84"H X 37"W X 24"D Initial	194
	V21-8424A	84"H X 36"W X 24"D Adder	156

84" High double sided shelving has an inverted wood cornice top and ten adjustable shelves. Includes 1/4" matching wood back.

90" High	Model Number	Description	Wt.
	V27-9024	90"H X 37"W X 24"D Initial	212
	V21-9024A	90"H X 36"W X 24"D Adder	172

90" High doublesided shelving has an inverted wood cornice top and twelve adjustable shelves. Includes 1/4" matching wood back.

Single Faced Picture Book Units

42" High	Model Number	Description	Wt.
	V27-4212P	42"H X 37"W X 12"D Picture Book Initial	72
	V21-4212PA	42"H X 36"W X 12"D Picture Book Adder	63

42" High single sided shelving has a wood top, one adjustable picture book shelf and one base picture book shelf. Includes 1/4" matching wood back.

48" High	Model Number	Description	Wt.
	V27-4812P	48"H X 37"W X 12"D Picture Book Initial	75
	V21-4812PA	48"H X 36"W X 12"D Picture Book Adder	64

48" High single sided shelving has a wood top, one adjustable picture book shelf and one base picture book shelf. Includes 1/4" matching wood back.

60" High	Model Number	Description	Wt.
	V27-6012P	60"H X 37"W X 12"D Picture Book Initial	94
	V21-6012PA	60"H X 36"W X 12"D Picture Book Adder	80

60" High single sided shelving has a wood top, two adjustable picture book shelves and one base picture book shelf. Includes 1/4" matching wood back.

Double Faced Picture Book Units

42" High	Model Number	Description	Wt.
	V27-4224P	42"H X 37"W X 24"D Picture Book Initial	134
	V21-4224PA	42"H X 36"W X 24"D Picture Book Adder	115

42" High double sided shelving has a wood top, two adjustable picture book shelf and one base picture book shelf per side. Includes 1/4" matching wood back.

42" High Mobile Unit	Model Number	Description	Wt.
	V27-4224P-MOB	42"H X 37"W X 24"D Picture Book Mobile	146

48" High	Model Number	Description	Wt.
	V27-4824P	48"H X 37"W X 24"D Picture Book Initial	140
	V21-4824PA	48"H X 36"W X 24"D Picture Book Adder	118

48" High double sided shelving has a wood top, two adjustable picture book shelf and one base picture book shelf. Includes 1/4" matching wood back.

48" High Mobile Unit	Model Number	Description	Wt.
	V27-4824P-MOB	48"H X 37"W X 24"D Picture Book Mobile	152

60" High	Model Number	Description	Wt.
	V27-6024P	60"H X 37"W X 24"D Picture Book Initial	174
	V21-6024PA	60"H X 36"W X 24"D Picture Book Adder	147

60" High double sided shelving has a wood top, four adjustable picture book shelves and one base picture book shelf. Includes 1/4" matching wood back.

Options How to Indicate

Steel Shelving Add "SB" to part number (SB21-3012) for standard steel shelves, "S" (S21-3012) for flat steel shelves

Required Item: Bookstacks

Proposed Line: 31-Series Steel Frame Bookcases



31-7212
Single Faced

31-XXXX for Wood Veneer
H31-XXXX for HPL
T31-XXXX for Melamine



31-4224
Double Faced

31-Series Bookcase

- Premium oak or maple veneer, high pressure laminate or melamine end panels
- Powder coated steel frame and shelves
- Wood banding with veneer end panels and PVC banding with laminate panels
- Bookshelf and picturebook shelves
- Steel magazine shelves optional
- End panels pre-drilled for optional leveling glides
- 42" and 48"H double-faced mobile bookcase

31-SERIES CONSTRUCTION

Wood Veneer Surfaces

Frame: 1" square 18-gauge steel tubing. Bolts to end and intermediate panels.

Top: veneer core; veneer faces; wood banding.

Locking cam fasteners lock the top and sides into place.

End and intermediate panels: veneer core; veneer faces; wood banding.

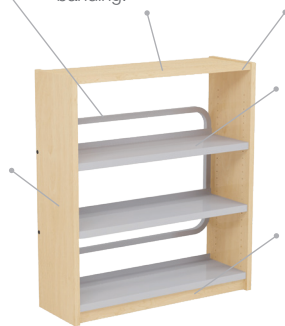

Adjustable shelves: 18-gauge steel with 1-1/4" deep triple bent edge and a 1-1/4" tall bookstop lip.

Toe Plates: veneer core; veneer face; attached to panels using 14-gauge steel brackets.

EXAMPLE:

31-Series 4212 Standard Starter Unit Model Number			
Shelves	Surface Material		
	Wood Veneer	HPL	Melamine
Steel	31-4212	H31-4212	T31-4212
Designer Lines:			
Malibu	32-4212	NA	NA
Metro	33-4212	NA	NA
Twist	36-4212	NA	NA
Lexington	37-4212	NA	NA
Charleston	38-4212	NA	NA
Heritage	39-4212	NA	NA

High-Pressure Laminate Surfaces

Frame: 1" square 18-gauge steel tubing. Bolts to end and intermediate panels.

Top: particle board core, high-pressure laminate faces; PVC banding.

Locking cam fasteners lock the top and sides into place.

End and intermediate panels: particle board core; high-pressure laminate on both faces; PVC banding.



Adjustable shelves: 18-gauge steel with 1-1/4" deep triple bent edge and a 1-1/4" tall bookstop lip.

Toe Plates: particle board core; high-pressure laminate face; attached to panels using 14-gauge steel brackets.

Melamine Surfaces

Back: 1" square 18-gauge steel tubing. Bolts to end and intermediate panels.

Top: particle board core; melamine faces; PVC banding.

Locking cam fasteners lock the top and sides into place.

End and intermediate panels: particle board core; melamine faces; PVC banding.



Adjustable shelves: 18-gauge steel with 1-1/4" deep triple bent edge and a 1-1/4" tall bookstop lip.

Toe Plates: particle board core; melamine face; attached to panels using 14-gauge steel brackets.

Finish Options



31-4224P
Double Faced Picture Book Shelving



Powder Coat
Steel Shelving

Required Item: Bookstacks

Proposed Line: 31-Series Steel Frame Bookcases

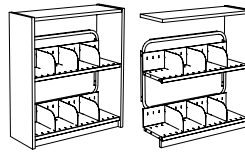
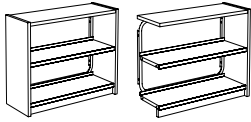

Single Faced Standard Units		Oak Veneer	High-Pressure Laminate	Melamine	
30" High	Description	Wt.	Part Number	Part Number	Part Number
	30"H x 37"W x 10-1/2"D, Initial	74	31-3010	H31-3010	T31-3010
	30"H x 36"W x 10-1/2"D, Adder	61	31-3010A	H31-3010A	T31-3010A
	30"H x 37"W x 12-1/2"D, Initial	80	31-3012	H31-3012	T31-3012
	30"H x 36"W x 12-1/2"D, Adder	65	31-3012A	H31-3012A	T31-3012A

36" High	Description	Wt.	Part Number	Part Number	Part Number
	36"H x 37"W x 10-1/2"D, Initial	82	31-3610	H31-3610	T31-3610
	36"H x 36"W x 10-1/2"D, Adder	69	31-3610A	H31-3610A	T31-3610A
	36"H x 37"W x 12-1/2"D, Initial	88	31-3612	H31-3612	T31-3612
	36"H x 36"W x 12-1/2"D, Adder	73	31-3612A	H31-3612A	T31-3612A

42" High	Description	Wt.	Part Number	Part Number	Part Number
	42"H x 37"W x 10-1/2"D, Initial	90	31-4210	H31-4210	T31-4210
	42"H x 36"W x 10-1/2"D, Adder	76	31-4210A	H31-4210A	T31-4210A
	42"H x 37"W x 12-1/2"D, Initial	96	31-4212	H31-4212	T31-4212
	42"H x 36"W x 12-1/2"D, Adder	80	31-4212A	H31-4212A	T31-4212A

48" High	Description	Wt.	Part Number	Part Number	Part Number
	48"H x 37"W x 10-1/2"D, Initial	92	31-4810	H31-4810	T31-4810
	48"H x 36"W x 10-1/2"D, Adder	78	31-4810A	H31-4810A	T31-4810A
	48"H x 37"W x 12-1/2"D, Initial	98	31-4812	H31-4812	T31-4812
	48"H x 36"W x 12-1/2"D, Adder	82	31-4812A	H31-4812A	T31-4812A

60" High	Description	Wt.	Part Number	Part Number	Part Number
	60"H x 37"W x 10-1/2"D, Initial	120	31-6010	H31-6010	T31-6010
	60"H x 36"W x 10-1/2"D, Adder	96	31-6010A	H31-6010A	T31-6010A
	60"H x 37"W x 12-1/2"D, Initial	126	31-6012	H31-6012	T31-6012
	60"H x 36"W x 12-1/2"D, Adder	79	31-6012A	H31-6012A	T31-6012A

72" High	Description	Wt.	Part Number	Part Number	Part Number
	72"H x 37"W x 10-1/2"D, Initial	134	31-7210	H31-7210	T31-7210
	72"H x 36"W x 10-1/2"D, Adder	106	31-7210A	H31-7210A	T31-7210A
	72"H x 37"W x 12-1/2"D, Initial	142	31-7212	H31-7212	T31-7212
	72"H x 36"W x 12-1/2"D, Adder	110	31-7212A	H31-7212A	T31-7212A

84" High	Description	Wt.	Part Number	Part Number	Part Number
	84"H x 37"W x 10-1/2"D, Initial	154	31-8410	H31-8410	T31-8410
	84"H x 36"W x 10-1/2"D, Adder	122	31-8410A	H31-8410A	T31-8410A
	84"H x 37"W x 12-1/2"D, Initial	164	31-8412	H31-8412	T31-8412
	84"H x 36"W x 12-1/2"D, Adder	127	31-8412A	H31-8412A	T31-8412A

90" High	Description	Wt.	Part Number	Part Number	Part Number
	90"H x 37"W x 10-1/2"D, Initial	176	31-9010	H31-9010	T31-9010
	90"H x 36"W x 10-1/2"D, Adder	139	31-9010A	H31-9010A	T31-9010A
	90"H x 37"W x 12-1/2"D, Initial	186	31-9012	H31-9012	T31-9012
	90"H x 36"W x 12-1/2"D, Adder	144	31-9012A	H31-9012A	T31-9012A

Single Faced Picture Book Display Units		Oak Veneer	High-Pressure Laminate	Melamine	
42" High	Description	Wt.	Part Number	Part Number	Part Number
	42"H x 37"W x 10-1/2"D, Initial	110	31-4210P	H31-4210P	T31-4210P
	42"H x 36"W x 10-1/2"D, Adder	96	31-4210PA	H31-4210PA	T31-4210PA
	42"H x 37"W x 12-1/2"D, Initial	121	31-4212P	H31-4212P	T31-4212P
	42"H x 36"W x 12-1/2"D, Adder	105	31-4212PA	H31-4212PA	T31-4212PA

48" High	Description	Wt.	Part Number	Part Number	Part Number
	48"H x 37"W x 10-1/2"D, Initial	112	31-4810P	H31-4810P	T31-4810P
	48"H x 36"W x 10-1/2"D, Adder	98	31-4810PA	H31-4810PA	T31-4810PA
	48"H x 37"W x 12-1/2"D, Initial	123	31-4812P	H31-4812P	T31-4812P
	48"H x 36"W x 12-1/2"D, Adder	107	31-4812PA	H31-4812PA	T31-4812PA

60" High	Description	Wt.	Part Number	Part Number	Part Number
	60"H x 37"W x 10-1/2"D, Initial	140	31-6010P	H31-6010P	T31-6010P
	60"H x 36"W x 10-1/2"D, Adder	116	31-6010PA	H31-6010PA	T31-6010PA
	60"H x 37"W x 12-1/2"D, Initial	151	31-6012P	H31-6012P	T31-6012P
	60"H x 36"W x 12-1/2"D, Adder	124	31-6012PA	H31-6012PA	T31-6012PA

72" High	Description	Wt.	Part Number	Part Number	Part Number
	72"H x 37"W x 10-1/2"D, Initial	158	31-7210P	H31-7210P	T31-7210P
	72"H x 36"W x 10-1/2"D, Adder	130	31-7210PA	H31-7210PA	T31-7210PA
	72"H x 37"W x 12-1/2"D, Initial	172	31-7212P	H31-7212P	T31-7212P
	72"H x 36"W x 12-1/2"D, Adder	140	31-7212PA	H31-7212PA	T31-7212PA

84" High	Description	Wt.	Part Number	Part Number	Part Number
	84"H x 37"W x 10-1/2"D, Initial	182	31-8410P	H31-8410P	T31-8410P
	84"H x 36"W x 10-1/2"D, Adder	150	31-8410PA	H31-8410PA	T31-8410PA
	84"H x 37"W x 12-1/2"D, Initial	199	31-8412P	H31-8412P	T31-8412P
	84"H x 36"W x 12-1/2"D, Adder	162	31-8412PA	H31-8412PA	T31-8412PA

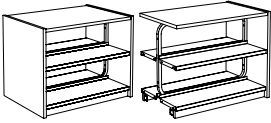

Double Faced Standard Units			Oak Veneer	High-Pressure Laminate	Melamine
30" High	Description	Wt.	Part Number	Part Number	Part Number
	30"H x 37"W x 20"D, Initial	124	31-3020	H31-3020	T31-3020
	30"H x 36"W x 20"D, Adder	102	31-3020A	H31-3020A	T31-3020A
	30"H x 37"W x 24"D, Initial	148	31-3024	H31-3024	T31-3024
	30"H x 36"W x 24"D, Adder	123	31-3024A	H31-3024A	T31-3024A

36" High	Description	Wt.	Part Number	Part Number	Part Number
	36"H x 37"W x 20"D, Initial	142	31-3620	H31-3620	T31-3620
	36"H x 36"W x 20"D, Adder	116	31-3620A	H31-3620A	T31-3620A
	36"H x 37"W x 20"D, Initial Mobile	154	31-3620-MOB	H31-3620-MOB	T31-3620-MOB
	36"H x 36"W x 20"D, Adder Mobile	128	31-3620A-MOB	H31-3620A-MOB	T31-3620A-MOB
	36"H x 37"W x 24"D, Initial	160	31-3624	H31-3624	T31-3624
	36"H x 36"W x 24"D, Adder	130	31-3624A	H31-3624A	T31-3624A
	36"H x 37"W x 24"D, Initial Mobile	172	31-3624-MOB	H31-3624-MOB	T31-3624-MOB
	36"H x 36"W x 24"D, Adder Mobile	142	31-3624A-MOB	H31-3624A-MOB	T31-3624A-MOB

42" High	Description	Wt.	Part Number	Part Number	Part Number
	42"H x 37"W x 20"D, Initial	160	31-4220	H31-4220	T31-4220
	42"H x 36"W x 20"D, Adder	129	31-4220A	H31-4220A	T31-4220A
	42"H x 37"W x 20"D, Initial Mobile	172	31-4220-MOB	H31-4220-MOB	T31-4220-MOB
	42"H x 36"W x 20"D, Adder Mobile	141	31-4220A-MOB	H31-4220A-MOB	T31-4220A-MOB
	42"H x 37"W x 24"D, Initial	172	31-4224	H31-4224	T31-4224
	42"H x 36"W x 24"D, Adder	137	31-4224A	H31-4224A	T31-4224A
	42"H x 37"W x 24"D, Initial Mobile	184	31-4224-MOB	H31-4224-MOB	T31-4224-MOB
	42"H x 37"W x 24"D, Adder Mobile	149	31-4224A-MOB	H31-4224A-MOB	T31-4224A-MOB

48" High	Description	Wt.	Part Number	Part Number	Part Number
	48"H x 37"W x 20"D, Initial	164	31-4820	H31-4820	T31-4820
	48"H x 36"W x 20"D, Adder	132	31-4820A	H31-4820A	T31-4820A
	48"H x 37"W x 20"D, Initial Mobile	176	31-4820-MOB	H31-4820-MOB	T31-4820-MOB
	48"H x 36"W x 20"D, Adder Mobile	144	31-4820A-MOB	H31-4820A-MOB	T31-4820A-MOB
	48"H x 37"W x 24"D, Initial	176	31-4824	H31-4824	T31-4824
	48"H x 36"W x 24"D, Adder	140	31-4824A	H31-4824A	T31-4824A
	48"H x 37"W x 24"D, Initial Mobile	188	31-4824-MOB	H31-4824-MOB	T31-4824-MOB
	48"H x 36"W x 24"D, Adder Mobile	152	31-4824A-MOB	H31-4824A-MOB	T31-4824A-MOB

60" High	Description	Wt.	Part Number	Part Number	Part Number
	60"H x 37"W x 20"D, Initial		31-6020	H31-6020	T31-6020
	60"H x 36"W x 20"D, Adder		31-6020A	H31-6020A	T31-6020A
	60"H x 37"W x 24"D, Initial		31-6024	H31-6024	T31-6024
	60"H x 36"W x 24"D, Adder		31-6024A	H31-6024A	T31-6024A

Double Faced Picture Book Display Units			Oak Veneer	High-Pressure Laminate	Melamine
42" High	Description	Wt.	Part Number	Part Number	Part Number
	42"H x 37"W x 20"D, Initial	184	31-4220P	H31-4220P	T31-4220P
	42"H x 36"W x 20"D, Adder	153	31-4220PA	H31-4220PA	T31-4220PA
	42"H x 37"W x 20"D, Initial Mobile	196	31-4220P-MOB	H31-4220P-MOB	T31-4220P-MOB
	42"H x 36"W x 20"D, Adder Mobile	165	31-4220PA-MOB	H31-4220PA-MOB	T31-4220PA-MOB
	42"H x 37"W x 24"D, Initial	202	31-4224P	H31-4224P	T31-4224P
	42"H x 36"W x 24"D, Adder	167	31-4224PA	H31-4224PA	T31-4224PA
	42"H x 37"W x 24"D, Initial Mobile	214	31-4224P-MOB	H31-4224P-MOB	T31-4224P-MOB
	42"H x 36"W x 24"D, Adder Mobile	179	31-4224PA-MOB	H31-4224PA-MOB	T31-4224PA-MOB

48" High	Description	Wt.	Part Number	Part Number	Part Number
	48"H x 37"W x 20"D, Initial	188	31-4820P	H31-4820P	T31-4820P
	48"H x 36"W x 20"D, Adder	157	31-4820PA	H31-4820PA	T31-4820PA
	48"H x 37"W x 20"D, Initial Mobile	200	31-4820P-MOB	H31-4820P-MOB	T31-4820P-MOB
	48"H x 36"W x 20"D, Adder Mobile	169	31-4820PA-MOB	H31-4820PA-MOB	T31-4820PA-MOB
	48"H x 37"W x 24"D, Initial	207	31-4824P	H31-4824P	T31-4824P
	48"H x 36"W x 24"D, Adder	171	31-4824PA	H31-4824PA	T31-4824PA
	48"H x 37"W x 24"D, Mobile	219	31-4824P-MOB	H31-4824P-MOB	T31-4824P-MOB
	48"H x 36"W x 24"D, Mobile	183	31-4824PA-MOB	H31-4824PA-MOB	T31-4824PA-MOB

72" High	Description	Wt.	Part Number	Part Number	Part Number
	72"H x 37"W x 20"D, Initial	206	31-7220	H31-7220	T31-7220
	72"H x 36"W x 20"D, Adder	172	31-7220A	H31-7220A	T31-7220A
	72"H x 37"W x 24"D, Initial	220	31-7224	H31-7224	T31-7224
	72"H x 36"W x 24"D, Adder	179	31-7224A	H31-7224A	T31-7224A

84" High	Description	Wt.	Part Number	Part Number	Part Number
	84"H x 37"W x 20"D, Initial	241	31-8420	H31-8420	T31-8420
	84"H x 36"W x 20"D, Adder	192	31-8420A	H31-8420A	T31-8420A
	84"H x 37"W x 24"D, Initial	257	31-8424	H31-8424	T31-8424
	84"H x 36"W x 24"D, Adder	199	31-8424A	H31-8424A	T31-8424A

90" High	Description	Wt.	Part Number	Part Number	Part Number
	90"H x 37"W x 20"D, Initial	325	31-9020	H31-9020	T31-9020
	90"H x 36"W x 20"D, Adder	258	31-9020A	H31-9020A	T31-9020A
	90"H x 37"W x 24"D, Initial	342	31-9024	H31-9024	T31-9024
	90"H x 36"W x 24"D, Adder	266	31-9024A	H31-9024A	T31-9024A

Required Item: Bookstacks

Proposed Line: Drift Mobile Bookcases

The footprint of each single faced Drift Curved Shelving unit is an 18" deep, 60 degree section of a 72" radius circle.

Double-faced Drift Curved Shelving is 24" deep and has shelving on both sides.



DFTS-4818V-M-MOB

DRIFT CONCAVE MOBILE BOOKCASE

- 42"H and 48"H single-face units available.
- 4 adjustable shelves on concave side.
- Constructed on a 60 degree curve
- Mates with other Drift units
- Custom Full Time Ottoman available for convex side (FTC-30-9624).
- Available with or without handles and magnets (insert "H" after DFT or DFTS for handles and magnets i.e. DFTH or DFTSH)
- Available in oak or maple veneer, haigh-pressure laminate or melamine finish.



DFT-4818V-M-MOB

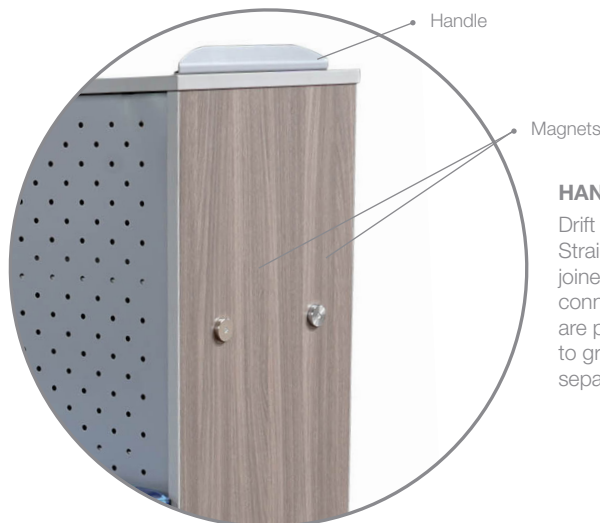

HANDLES AND MAGNETS

Drift Curved Shelving and Straight Storage units can be joined together with optional connecting magnets. Handles are provided to provide a place to grasp when joining and separating the units.



DFTS-4818X-M-MOB

DRIFT CONVEX MOBILE BOOKCASE

- 42"H and 48"H single-face units available.
- 4 adjustable shelves on convex side.
- Constructed on a 60 degree curve
- Mates with other Drift units
- Full Time Ottomans available to nest in concave side (2 x FTC-30).
- Available with or without handles and magnets (insert "H" after DFT or DFTS for handles and magnets i.e. DFTH or DFTSH)
- Available in oak or maple veneer, high-pressure laminate or melamine finish.



DFT-4818X-M-MOB



DFT-4224D-M-MOB

DRIFT DOUBLE-FACED MOBILE BOOKCASE

- 42"H and 48"H double-face units available.
- 4 adjustable shelves on each side.
- Constructed on a 60 degree curve
- 24" Deep, Steel "back"
- Available with or without handles and magnets (insert "H" after DFTS for handles and magnets i.e. DFTSH)

*18"D DRIFT units with connecting magnets are designed to connect with only 18"D DRIFT units.
24"D DRIFT units with connecting magnets are designed to connect with only 24"D DRIFT units.*

Required Item: Bookstacks

Proposed Line: Drift Mobile Bookcases



DFTS-4818X-M-MOB

SINGLE-FACED, OAK VENEER CONSTRUCTION - Wood Panel Back - Ships Assembled

Oak	Model Number	Description	Wt
Concave Shelving (Shelves on Inner Curve)			
	DFT-4218V-O-MOB	18"D x 72"W x 42"H, Oak, 4 adj. shelves on Inner Curve	100
	DFT-4818V-O-MOB	18"D x 72"W x 48"H, Oak, 4 adj. shelves on Inner Curve	128

Convex Shelving (Shelves on Outer Curve)			
	DFT-4218X-O-MOB	18"D x 72"W x 42"H, Oak, 4 adj. shelves on Outer Curve	100
	DFT-4818X-O-MOB	18"D x 72"W x 48"H, Oak, 4 adj. shelves on Outer Curve	128

Concave Shelving (Shelves on Inner Curve) with Handles and Connecting magnets			
	DFTH-4218V-O-MOB	18"D x 72"W x 42"H, Oak, 4 adj. shelves on Inner Curve	100
	DFTH-4818V-O-MOB	18"D x 72"W x 48"H, Oak, 4 adj. shelves on Inner Curve	128

Convex Shelving (Shelves on Outer Curve) with Handles and Connecting magnets			
	DFTH-4218X-O-MOB	18"D x 72"W x 42"H, Oak, 4 adj. shelves on Outer Curve	100
	DFTH-4818X-O-MOB	18"D x 72"W x 48"H, Oak, 4 adj. shelves on Outer Curve	128

SINGLE-FACED, OAK VENEER CONSTRUCTION - Perforated Metal Panel Back - Ships Assembled

Oak	Model Number	Description	Wt
Concave Shelving (Shelves on Inner Curve)			
	DFTS-4218V-O-MOB	18"D x 72"W x 42"H, Oak, 4 adj. shelves on Inner Curve	100
	DFTS-4818V-O-MOB	18"D x 72"W x 48"H, Oak, 4 adj. shelves on Inner Curve	128

Convex Shelving (Shelves on Outer Curve)			
	DFTS-4218X-O-MOB	18"D x 72"W x 42"H, Oak, 4 adj. shelves on Outer Curve	100
	DFTS-4818X-O-MOB	18"D x 72"W x 48"H, Oak, 4 adj. shelves on Outer Curve	128

Concave Shelving (Shelves on Inner Curve) with Handles and Connecting magnets			
	DFTSH-4218V-O-MOB	18"D x 72"W x 42"H, Oak, 4 adj. shelves on Inner Curve	100
	DFTSH-4818V-O-MOB	18"D x 72"W x 48"H, Oak, 4 adj. shelves on Inner Curve	128

Convex Shelving (Shelves on Outer Curve) with Handles and Connecting magnets			
	DFTSH-4218X-O-MOB	18"D x 72"W x 42"H, Oak, 4 adj. shelves on Outer Curve	100
	DFTSH-4818X-O-MOB	18"D x 72"W x 48"H, Oak, 4 adj. shelves on Outer Curve	128

DOUBLE-FACED, OAK VENEER CONSTRUCTION - Perforated Metal Back Panel - Ships Assembled

Oak	Model Number	Description	Wt
Double-Faced (Shelves on Both Sides)			
	DFTS-4224D-O-MOB	24"D x 67"W x 42"H, Oak, 4 adj. shelves on each side	130
	DFTS-4824D-O-MOB	24"D x 67"W x 48"H, Oak, 4 adj. shelves on each side	167

Double-Faced (Shelves on Both Sides) with Handles and Connecting magnets			
	DFTSH-4224D-O-MOB	24"D x 67"W x 42"H, Oak, 4 adj. shelves on each side	130
	DFTSH-4824D-O-MOB	24"D x 67"W x 48"H, Oak, 4 adj. shelves on each side	167

SINGLE-FACED, MAPLE VENEER CONSTRUCTION - Wood Panel Back - Ships Assembled

Maple	Model Number	Description	Wt
Concave Shelving (Shelves on Inner Curve)			
	DFT-4218V-M-MOB	18"D x 72"W x 42"H, Maple, 4 adj. shelves on Inner Curve	100
	DFT-4818V-M-MOB	18"D x 72"W x 48"H, Maple, 4 adj. shelves on Inner Curve	128

Convex Shelving (Shelves on Outer Curve)			
	DFT-4218X-M-MOB	18"D x 72"W x 42"H, Maple, 4 adj. shelves on Outer Curve	100
	DFT-4818X-M-MOB	18"D x 72"W x 48"H, Maple, 4 adj. shelves on Outer Curve	128

Concave Shelving (Shelves on Inner Curve) with Handles and Connecting magnets			
	DFTH-4218V-M-MOB	18"D x 72"W x 42"H, Maple, 4 adj. shelves on Inner Curve	100
	DFTH-4818V-M-MOB	18"D x 72"W x 48"H, Maple, 4 adj. shelves on Inner Curve	128

Convex Shelving (Shelves on Outer Curve) with Handles and Connecting magnets			
	DFTH-4218X-M-MOB	18"D x 72"W x 42"H, Maple, 4 adj. shelves on Outer Curve	100
	DFTH-4818X-M-MOB	18"D x 72"W x 48"H, Maple, 4 adj. shelves on Outer Curve	128

SINGLE-FACED, MAPLE VENEER CONSTRUCTION - Perforated Metal Panel Back - Ships Assembled

Maple	Model Number	Description	Wt
Concave Shelving (Shelves on Inner Curve)			
	DFTS-4218V-M-MOB	18"D x 72"W x 42"H, Maple, 4 adj. shelves on Inner Curve	100
	DFTS-4818V-M-MOB	18"D x 72"W x 48"H, Maple, 4 adj. shelves on Inner Curve	128

Convex Shelving (Shelves on Outer Curve)			
	DFTS-4218X-M-MOB	18"D x 72"W x 42"H, Maple, 4 adj. shelves on Outer Curve	100
	DFTS-4818X-M-MOB	18"D x 72"W x 48"H, Maple, 4 adj. shelves on Outer Curve	128

Concave Shelving (Shelves on Inner Curve) with Handles and Connecting magnets			
	DFTSH-4218V-M-MOB	18"D x 72"W x 42"H, Maple, 4 adj. shelves on Inner Curve	100
	DFTSH-4818V-M-MOB	18"D x 72"W x 48"H, Maple, 4 adj. shelves on Inner Curve	128

Convex Shelving (Shelves on Outer Curve) with Handles and Connecting magnets			
	DFTSH-4218X-M-MOB	18"D x 72"W x 42"H, Maple, 4 adj. shelves on Outer Curve	100
	DFTSH-4818X-M-MOB	18"D x 72"W x 48"H, Maple, 4 adj. shelves on Outer Curve	128

DOUBLE-FACED, MAPLE VENEER CONSTRUCTION - Perforated Metal Back - Ships Assembled

Maple	Model Number	Description	Wt
Double-Faced (Shelves on Both Sides)			
	DFTS-4224D-M-MOB	24"D x 67"W x 42"H, Maple, 4 adj. shelves on each side	130
	DFTS-4824D-M-MOB	24"D x 67"W x 48"H, Maple, 4 adj. shelves on each side	167

Double-Faced (Shelves on Both Sides) with Handles and Connecting magnets			
	DFTSH-4224D-M-MOB	24"D x 67"W x 42"H, Maple, 4 adj. shelves on each side	130
	DFTSH-4824D-M-MOB	24"D x 67"W x 48"H, Maple, 4 adj. shelves on each side	167



SINGLE-FACED, HIGH PRESSURE LAMINATE CONSTRUCTION - Laminate Back Panel - Ships Assembled

HPL	Model Number	Description	Wt.
Concave Shelving (Shelves on Inner Curve)			
	DFT-4218V-L-MOB	18"D x 72"W x 42"H, HPL, 4 adj. shelves on Inner Curve	100
	DFT-4818V-L-MOB	18"D x 72"W x 48"H, HPL, 4 adj. shelves on Inner Curve	128

Convex Shelving (Shelves on Outer Curve)			
	DFT-4218X-L-MOB	18"D x 72"W x 42"H, HPL, 4 adj. shelves on Outer Curve	100
	DFT-4818X-L-MOB	18"D x 72"W x 48"H, HPL, 4 adj. shelves on Outer Curve	128

Concave Shelving (Shelves on Inner Curve) with Handles and Connecting Magnets			
	DFTH-4218V-L-MOB	18"D x 72"W x 42"H, HPL, 4 adj. shelves on Inner Curve	100
	DFTH-4818V-L-MOB	18"D x 72"W x 48"H, HPL, 4 adj. shelves on Inner Curve	128

Convex Shelving (Shelves on Outer Curve) with Handles and Connecting Magnets			
	DFTH-4218X-L-MOB	18"D x 72"W x 42"H, HPL, 4 adj. shelves on Outer Curve	100
	DFTH-4818X-L-MOB	18"D x 72"W x 48"H, HPL, 4 adj. shelves on Outer Curve	128

SINGLE-FACED, HIGH PRESSURE LAMINATE CONSTRUCTION - Perforated Metal Back Panel - Ship Assembled

HPL	Model Number	Description	Wt.
Concave Shelving (Shelves on Inner Curve)			
	DFTS-4218V-L-MOB	18"D x 72"W x 42"H, HPL, 4 adj. shelves on Inner Curve	100
	DFTS-4818V-L-MOB	18"D x 72"W x 48"H, HPL, 4 adj. shelves on Inner Curve	128

Convex Shelving (Shelves on Outer Curve)			
	DFTS-4218X-L-MOB	18"D x 72"W x 42"H, HPL, 4 adj. shelves on Outer Curve	100
	DFTS-4818X-L-MOB	18"D x 72"W x 48"H, HPL, 4 adj. shelves on Outer Curve	128

Concave Shelving (Shelves on Inner Curve) with Handles and Connecting Magnets			
	DFTSH-4218V-L-MOB	18"D x 72"W x 42"H, HPL, 4 adj. shelves on Inner Curve	100
	DFTSH-4818V-L-MOB	18"D x 72"W x 48"H, HPL, 4 adj. shelves on Inner Curve	128

Convex Shelving (Shelves on Outer Curve) with Handles and Connecting Magnets			
	DFTSH-4218X-L-MOB	18"D x 72"W x 42"H, HPL, 4 adj. shelves on Outer Curve	100
	DFTSH-4818X-L-MOB	18"D x 72"W x 48"H, HPL, 4 adj. shelves on Outer Curve	128

DOUBLE FACED, HIGH PRESSURE LAMINATE CONSTRUCTION - Perforated Metal Back Panel - Ships Assembled

HPL	Model Number	Description	Wt.
Double-Faced (Shelves on Both Sides)			
	DFTS-4224D-L-MOB	24"D x 67"W x 42"H, HPL, 4 adj. shelves on each side	130
	DFTS-4824D-L-MOB	24"D x 67"W x 48"H, HPL, 4 adj. shelves on each side	167

Double-Faced (Shelves on Both Sides) with Handles and Connecting Magnets			
	DFTSH-4224D-L-MOB	24"D x 67"W x 42"H, HPL, 4 adj. shelves on each side	130
	DFTSH-4824D-L-MOB	24"D x 67"W x 48"H, HPL, 4 adj. shelves on each side	167

SINGLE-FACED, MELAMINE CONSTRUCTION - Perforated Metal Back Panel - Ships Assembled

TFL	Model Number	Description	Wt.
Concave Shelving (Shelves on Inner Curve)			
	DFTS-4218V-T-MOB	18"D x 72"W x 42"H, TFL, 4 adj. shelves on Inner Curve	100
	DFTS-4818V-T-MOB	18"D x 72"W x 48"H, TFL, 4 adj. shelves on Inner Curve	128

Convex Shelving (Shelves on Outer Curve)			
	DFTS-4218X-T-MOB	18"D x 72"W x 42"H, TFL, 4 adj. shelves on Outer Curve	100
	DFTS-4818X-T-MOB	18"D x 72"W x 48"H, TFL, 4 adj. shelves on Outer Curve	128

Concave Shelving (Shelves on Inner Curve) with Handles and Connecting Magnets			
	DFTSH-4218V-T-MOB	18"D x 72"W x 42"H, TFL, 4 adj. shelves on Inner Curve	100
	DFTSH-4818V-T-MOB	18"D x 72"W x 48"H, TFL, 4 adj. shelves on Inner Curve	128

Convex Shelving (Shelves on Outer Curve) with Handles and Connecting Magnets			
	DFTSH-4218X-T-MOB	18"D x 72"W x 42"H, TFL, 4 adj. shelves on Outer Curve	100
	DFTSH-4818X-T-MOB	18"D x 72"W x 48"H, TFL, 4 adj. shelves on Outer Curve	128

DOUBLE-FACED, MELAMINE CONSTRUCTION - Perforated Metal Back Panel - Ships Assembled

TFL	Model Number	Description	Wt.
Double-Faced (Shelves on Both Sides)			
	DFTS-4224D-T-MOB	24"D x 67"W x 42"H, TFL, 4 adj. shelves on each side	130
	DFTS-4824D-T-MOB	24"D x 67"W x 48"H, TFL, 4 adj. shelves on each side	167

Double-Faced (Shelves on Both Sides) with Handles and Connecting Magnets			
	DFTSH-4224D-T-MOB	24"D x 67"W x 42"H, TFL, 4 adj. shelves on each side	130
	DFTSH-4824D-T-MOB	24"D x 67"W x 48"H, TFL, 4 adj. shelves on each side	167

Required Item: Atlas Stand

Proposed Line: Bookmark

Additional Lines: Charleston, Heritage, Lexington, Malibu, Metro, Twist



B2424AS

Required Item: Dictionary Stand

Proposed Line: Bookmark

Additional Lines: Charleston, Heritage, Lexington, Malibu, Metro, Twist



B2024DS

Bookmark Atlas Stand

Key Features

- Laminate work surface.
- Oak or maple veneer case.(Sprayon available)
- Standard height features 5 pull out shelves.
- Available in juvenile height that consists of 4 pull out shelves.
- Unit is available in designer lines.

Bookmark Dictionary Stand

Key Features

- Laminate work surface.
- Oak or maple veneer case. (Sprayon available)
- Available in juvenile height
- Unit is available in designer lines.

Atlas Stand	Model Number	Description	Wt.
Bookmark	B2424AS	24" D X 24" W X 45" H	150
Bookmark Juvenile	B2424AS-J	24" D X 24" W X 34" H	146
*Charleston	CL2424AS	24" D X 24" W X 45" H	150
*Heritage	H2424AS	24" D X 24" W X 45" H	150
*Lexington	L2424AS	24" D X 24" W X 45" H	150
*Malibu	MB2424AS	24" D X 24" W X 45" H	150
*Metro	M2424AS	24" D X 24" W X 45" H	152
*Twist	TW2424AS	24" D X 24" W X 45" H	152

Dictionary Stand	Model Number	Description	Wt.
Bookmark	B2024DS	20" D X 24" W X 45" H	115
Bookmark Juvenile	B2024DS-J	20" D X 24" W X 34" H	101
*Charleston	CL2024DS	20" D X 24" W X 45" H	104
*Heritage	H2024DS	20" D X 24" W X 45" H	115
*Lexington	L2024DS	20" D X 24" W X 45" H	115
*Malibu	MB2024DS	20" D X 24" W X 45" H	115
*Metro	M2024DS	20" D X 24" W X 45" H	115
*Twist	TW2024DS	20" D X 24" W X 45" H	115

General Specifications

The sloped top is 1-1/4" thick three ply engineered wood with a .050" thick laminate top with 1/8" solid red oak edge bands. The cabinet is constructed of 1-3/16" engineered wood with select red oak faces. All exposed edges are banded with 1/8" solid red oak. The unit has five adjustable 3/4" thick pull out shelves with a 1-1/2" solid oak front retainer. Juvenile height is 34" with 4 pull out shelves.

Available in Designer Lines* versions.

General Specifications

The sloped top is 1-1/4" thick three ply engineered wood with a .050" thick laminate top with 1/8" solid red oak edge bands. The cabinet is constructed of 1-3/16" engineered wood with select red oak faces. All exposed edges are banded with 1/8" solid red oak. The unit has one adjustable 3/4" thick shelf. Juvenile height is 34".

Available in Designer Lines* versions.

Required Item: Big Book Storage

Proposed Line: Bookmark

Required Item: Miscellaneous Displays/Racks/Stands for Newspapers and Magazines, etc.

Proposed Line: Bookmark



BD-2630BBD



B2036MR

Big Book Display

Key Features

- Display features 8 pullout shelves in a melamine of your choice.
- Case is finished in your choice of laminate or melamine.
- Unit is mobile by means of 2" diameter concealed casters.

Shown with revolving dictionary stand
B1521RDS

Magazine Rack

Key Features

- Hardwood construction with your choice of oak, maple or sprayon finishes.
- Features 5 sloped display shelves set at descending heights.

Big Book Display	Model Number	Description	Wt.
	BD-2630BBD	20" D X 26" W X 30" H	110

Magazine Rack	Model Number	Description	Wt.
	B2036MR	18" D X 36" W X 49" H	144

General Specifications

The top is 1-1/4" thick three ply engineered wood with a .050" thick laminate top with 1/8" solid red oak edge bands. The cabinet is constructed of 1-3/16" engineered wood with select red oak faces. All exposed edges are banded with 1/8" solid red oak. The unit has eight pull out shelves. Concealed 2" diameter casters are bolted to a steel chassis that fits inside the wood toe.

General Specifications

The end panels are 1" thick hardwood plywood with select red oak faces and 1/8" solid red oak bands on exposed edges. The closed back is 3/4" thick veneered plywood set into the end panels. The magazine display cabinet has five sloped display shelves at descending heights.



Required Item: Miscellaneous Displays/Racks/Stands for Newspapers and Magazines, etc.

Proposed Line: Bookmark



K1818MMR

Required Item: Miscellaneous Displays/Racks/Stands for Newspapers and Magazines, etc.

Proposed Line: Bookmark



11-4216MS-EOR

Spotlight

Key Features

- The display has (10) sloped display shelves at descending heights on each of its three sides.
- Hardwood construction with your choice of oak, maple or sprayon finishes.
- Swivel casters are fastened to the display unit base with wood screws.

EOR Magazine Display

Key Features

- End-of-Range Display
- Hardwood construction with oak banding with your choice of oak, maple or sprayon finishes.
- Clear plexiglass front

Spotlight Magazine Rack	Model Number	Description	Wt.
	K1818MMR	20" Diameter X 48" H	90

End of Range Magazine Display	Model Number	Description	Wt.
	11-4216MS-EOR	16" D X 24" W X 42" H	68

General Specifications

The base and end panels are 1" thick hardwood plywood with select red oak faces and 1/8" solid red oak bands on exposed edges. Swivel casters are fastened to the display unit base with wood screws. The mobile magazine display has ten sloped display shelves at descending heights on each of its three sides. Capacity for 30 magazines

General Specifications

Designed for end-of-run applications. End panels are 1" veneer core hardwood plywood with grade A oak veneer face and with a 1.5mm solid wood banding. Shelves are 1" veneer core hardwood plywood with grade A oak veneer face and with a 1.5mm solid wood banding. Each shelf has a clear plexiglass front retainer that allows display of magazine covers. Bottom shelf is 1" three ply construction with grade A oak veneer face and 1.5mm solid wood banding. Backs are 1/4" plywood with grade A oak veneer. Toes are constructed of 4" high and 1" thick veneer core hardwood plywood and are attached using 14-gauge steel brackets.



Required Item: Miscellaneous Displays/Racks/Stands for Newspapers and Magazines, etc.

Proposed Line: Bookmark



B2642NR

Newspaper Rack

Key Features

- Engineered wood frame with both sides covered in laminate.
- Top frame has notched racks at each end for 10 newspaper display rods
- Legs are hardwood

Newspaper Rack	Model Number	Description	Wt.
Bookmark	B2642NR	26" D X 42" W X 29" H	55
*Charleston	CL2642NR	26" D X 42" W X 29" H	57
*Heritage	H2642NR	26" D X 42" W X 29" H	59
*Lexington	L2642NR	26" D X 42" W X 29" H	57
*Malibu	MB2642NR	26" D X 42" W X 29" H	57
*Metro	M2642NR	26" D X 42" W X 29" H	54
*Twist	TW2642NR	26" D X 42" W X 29" H	70

General Specifications

The newspaper rack has an engineered panel frame, 1-1/4" thick with the face covered in .050" thick laminate. The top frame has notched racks at each end, which hold ten newspaper display rods. The newspapers hang in the opening of the table top. The legs are 2-1/4" solid glued up red oak and are attached to the top by means of a steel plate.

Available in Designer Lines* versions.

Required Item: Music/Book/Video Display

Proposed Line: Bookmark



B3636OCT

Octagonal

Key Features

- Hardwood construction with hardwood banding
- Adjustable shelves are hardwood with hardwood nosing
- Tops are engineered wood with high pressure laminate top face and a phenolic backer
- Base conceals eight 3" casters

Octagonal	Model Number	Finish	Wt.
	B3636OCT	Oak	255

General Specifications

Tops are 1-1/4" thick three ply engineered wood construction with .050" thick high-pressure laminate and a phenolic backer sheet. The standard edge is 1/8" solid red oak with a 1/8" radius all around. The adjustable shelves are 3/4" thick solid glued up hardwood. The nosing is 1-3/4" thick solid red oak. All wood components are 1" thick hardwood with grade AA red oak. All edges are finished with a 1/8" solid hardwood edgeband with a 1/8" radius top and bottom. The base of the unit is terminated with a solid oak decorative trim at the base, which conceals eight 3" diameter casters. Four sides feature two shelves with one adjustable and one base shelf per section. Shelves adjust on 32mm increments. The other four sides are slatwall with wood veneer slats. Unit also comes with an 8" high upper octagonal display unit that is mounted at the center of the worksurface for additional display.

Required Item: Music/Book/Video Display

Proposed Line: Bookmark



B3636SQ-MOB

Required Item: Music/Book/Video Display

Additional Line Item



DS2424OC5-60-L-MOB

Qubie

Key Features

- One open storage cabinet with 2 adjustable shelves per side
- Engineered wood construction available in oak or maple veneer, high-pressure laminate or melamine finishes.
- Four twin locking casters
- 36" x 36" x 36"

Highrise

Key Features

- Four open storage compartments per level
- Engineered wood construction available in high-pressure laminate finish with PVC banding
- Four twin locking casters
- 24" x 24"

Qubie Mobile Display	Model Number	Finish	Wt.
	B3636SQ-T-MOB	TFL	80
	B3636SQ-L-MOB	HPL	80
	B3636SQ-O-MOB	Oak	80
	B3636SQ-M-MOB	Maple	80

Highrise Mobile Display	
HPL Construction - PVC Edgeband	
Model Number	Description
DS2424OC3-36-L MOB	24"D x 24"W x 38"H, 3 cubicles per side, 4 casters
DS2424OC4-48-L-MOB	24"D x 24"W x 48"H, 4 cubicles per side, 4 casters
DS2424OC5-60-L-MOB	24"D x 24"W x 60"H, 5 cubicles per side, 4 casters

General Specifications

Cabinet construction is 3/4" thick engineered wood side panels, sub tops, vertical dividers and shelves. Dowel and glue construction. Top and base are 1-1/4" engineered wood. Box finish available to be applied to all display faces includes thermally fused laminate, high-pressure laminate and grade AA oak or maple veneer. Four twin locking casters are attached to the base via threaded inserts.



Required Item: Music/Book/Video Display

Proposed Line Item



K2436BB-MOB

Required Item: Music/Book/Video Display

Additional Line Item



K2436ABB-J-MOB

Binny

Key Features

- Veneer core hardwood plywood construction with oak veneer face and solid oak banding
- Mobile version has concealed casters bolted to steel chassis inside with wood toe
- 24" x 36" x 36"

Binny Browser Bin	Model Number	Description	Wt.
	K2436BB	24" D X 36" W X 36" H	80
	K2436BB-MOB	24" D X 36" W X 36" H	80

General Specifications

The end panels are 1" thick veneer core hardwood plywood with grade A oak veneer face and 1.5mm solid red oak banding. Bottom shelf and browser bin with dividers are all 1" three ply construction with grade A oak veneer face and 1.5mm solid red oak banding. Toes are constructed of 4" high 1" thick veneer core hardwood plywood and are attached using 14-gauge steel brackets. Concealed 2" diameter casters are bolted to a steel chassis that fits inside the wood toe on mobile unit.

Browser

Key Features

- Veneer core hardwood plywood construction with oak veneer face and solid oak banding
- Adjustable metal rod dividers
- Concealed casters bolted to steel chassis inside with wood toe
- 24" x 36" x 30"

Browser Bin	Model Number	Description	Wt.
	K2436ABB-J-MOB	24" D X 36" W X 30" H	80

General Specifications

The end panels are 1" thick veneer core hardwood plywood with grade A oak veneer face and 1.5mm solid red oak banding. Bottom shelf and browser bin with dividers are all 1" three ply construction with grade A oak veneer face and 1.5mm solid red oak banding. Toes are constructed of 4" high 1" thick veneer core hardwood plywood and are attached using 14-gauge steel brackets. Concealed 2" diameter casters are bolted to a steel chassis that fits inside the wood toe on mobile unit.



Required Item: Music/Book/Video Display

Additional Line Item



TS-4665-MSWD

Required Item: Music/Book/Video Display

Additional Line Item



11-4217BS

46

3-Sided Display Kiosk

Key Features

- Top and base are engineered wood with high-pressure laminate faces and PVC banding.
- Display faces are 3/4" high-pressure laminate slatwall.
- 1-1/2" diameter black powder coated steel tubes extend from top to base
- 3" casters

3-sided Display Kiosk	Model Number	Description
	TS-4665-MSWD	46" W x 40" Depth x 65" H

General Specifications

Three 1-1/2" diameter black powder coated steel posts extend from base shelf to top. All structural members use metal to metal fasteners. Display faces on all three sides are 3/4" high-pressure laminate slatwall. Top and base are 1-1/4" thick high-pressure laminate with PVC edge banding. 3" diameter casters are mounted to the display base. Corners on display top and base are radiused.

Bookstore Display

Key Features

- End panels and shelves are veneer core hardwood plywood construction with oak veneer face and solid oak banding
- Backs are 1/4" plywood with grade A oak veneer faces

Bookstore Display	Model Number	Description	Wt.
1 Adj., 1 Top, 1 Base - Shelves	11-4217BS	42" H X 17" D Starter, Single Faced	92
1 Adj., 1 Top, 1 Base - Shelves	11-4217BSA	42" H X 17" D Adder, Single Faced	84
3 Adj., 1 Top, 1 Base - Shelves	11-6017BS	60" H X 17" D Starter, Single Faced	130
3 Adj., 1 Top, 1 Base - Shelves	11-6017BSA	60" H X 17" D Adder, Single Faced	114
2 Adj., 2 Top, 2 Base - Shelves	11-4233BS	42" H X 33" D Starter, Double Faced	105
2 Adj., 2 Top, 2 Base - Shelves	11-4233BSA	42" H X 33" D Adder, Double Faced	93
6 Adj., 2 Top, 2 Base - Shelves	11-6033BS	60" H X 33" D Starter, Double Faced	245
6 Adj., 2 Top, 2 Base - Shelves	11-6033BSA	60" H X 33" D Adder, Double Faced	210

General Specifications

End panels are 1" veneer core hardwood plywood with grade A oak veneer face and with a 1.5mm solid wood banding. Shelves are 1" veneer core hardwood plywood with grade A oak veneer face and with a 1.5mm solid wood banding. Bottom shelf and top cross panel are 1" three ply construction with grade A oak veneer face and 1.5mm solid wood banding. Backs are 1/4" plywood with grade A oak veneer. Toes are constructed of 4" high and 1" thick veneer core hardwood plywood and are attached using 14-gauge steel brackets.

Required Item: Music/Book/Video Display

Additional Line Item



TDDF-3630 60

Tapered Display

Key Features

- Inner display structure is 3/4" thick engineered wood and veneer face base shelf and 1" thick nine ply hardwood plywood toe assembly.
- Adjustable shelves are 1" thick plywood hardwood with grade A oak veneer.
- Exposed edges are banded hardwood.
- End panels are constructed of 1" thick nine ply plywood hardwood with premium grade A oak veneer on both faces. Exposed edges are banded with 1/8" solid wood edges and corners are radiused 1/8"

Tapered Display	Model Number	Description	Wt.
	TDDF-3630-M-60	Maple, 30"D x 36"W x 60"H	245
	TDDF-3630-60-M-MOB	Maple, 30"D x 36"W x 60"H, Mobile	245
	TDDF-3630-O-60	Oak, 30"D x 36"W x 60"H	245
	TDDF-3630-60-O-MOB	Oak, 30"D x 36"W x 60"H, Mobile	245
	TDDF-3630-L-60	HPL, 30"D x 36"W x 60"H	245
	TDDF-3630-L-60-MOB	HPL, 30"D x 36"W x 60"H, Mobile	245
	TDDF-3630-T-60	Melamine, 30"D x 36"W x 60"H	245
	TDDF-3630-T-60-MOB	Melamine, 30"D x 36"W x 60"H, Mobile	245

General Specifications

Inner display structure is dowel and glue construction and incorporates 3/4" thick engineered wood and veneer face base shelf and 1" thick nine ply hardwood plywood toe assembly. Adjustable shelves are 1" thick nine ply plywood hardwood with premium grade A oak veneer. Exposed edges are banded with 1/8" solid wood edges and corners are radiused 1/8". Shelves are mounted at an angle - exterior edge is higher than interior edge. End panels are tapered, becoming narrower from bottom to top and are constructed of 1" thick nine ply plywood hardwood with premium grade A oak veneer on both faces. Exposed edges are banded with 1/8" solid wood edges and corners are radiused 1/8".



Required Item: Circulation Desk

Proposed Line: Bookmark

Additional Lines: Keystone, Malibu, Lexington, Metro

Bookmark Modular Circulation Desks

Key Features

- Over 20 Modular components to choose from
- High pressure laminate work surface
- Continuous tops available
- Cabinets are engineered wood construction with oak or maple veneer or high pressure laminate finish.
- Custom Circulation Desks available



Bookmark Desk

48

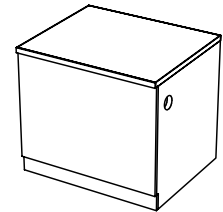
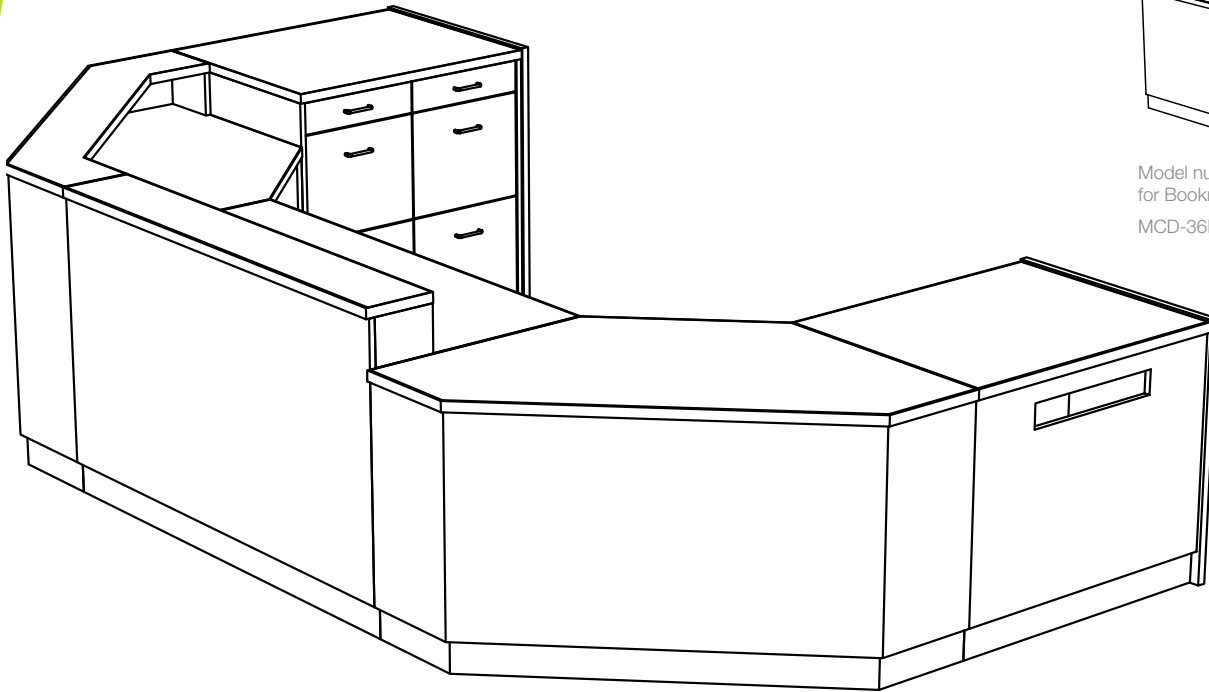

Model number example for Bookmark desk unit:
MCD-36D-29

COMPONENTS FROM EXAMPLE

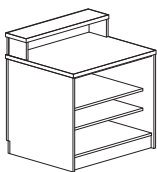

A MCD-360S-32-39 TRX

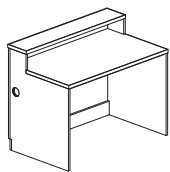

B MCD-48D-32-TRX39

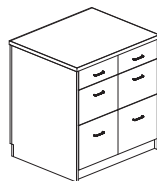

C MCD-36C6D-39

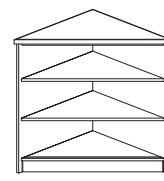

D MCD-30TCS-39

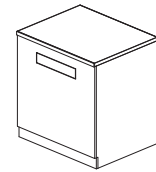

E MCD-36BR-39

Circulation desk configured with Bookmark Modular Circulation Desk components. Individual tops. High-pressure laminate finishes with PVC Edgebanding.



"Circle" Circulation desk configured with 6 Bookmark 60-degree curved modules.

Note the continuous top. (Pay no attention to the custom transaction top). Mobile pedestal storage with matching finish.

STANDARD DESIGN FACES FOR MODULAR CIRCULATION DESKS

Bookmark - Proposed

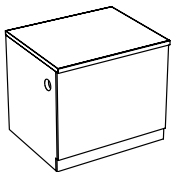

No detail. Model Number example for Bookmark desk unit is MCD-36D-29

Keystone - Additional

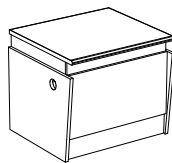

A modern design using laminate inlay details and tapered end panels. Model Number example for Keystone desk unit is MCD-**KS**-36D-29

Malibu - Additional

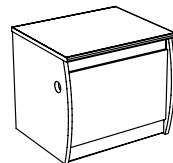

A modern style design using curved end panels with laminate inlay details at top and bottom applied to the patron side of most modular units. Model Number example for Malibu desk unit is MCD-**MB**-36D-29

Lexington - Additional

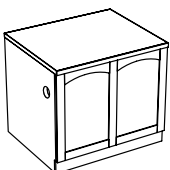

A classic arched rail and stile design line, using solid oak details applied to the patron side of most modular units. Model Number example for Lexington desk unit MCD-**L**-36D-29

Metro - Additional

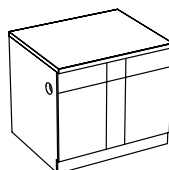

A clean and stylish design line detailed with 1/8" deep x 1/8" wide grooves painted black applied to the patron side of most modular units. Model Number example for Metro desk unit MCD-**M**-36D-29

BOLD Letter indicates addition to model number for each individual "Design" line

Required Item: Circulation Desk

Proposed Line: Bookmark

Additional Lines: Keystone, Malibu, Lexington, Metro

BOOKMARK STATEMENT OF LINE

Desk Units

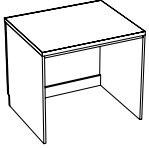

MCD-36D

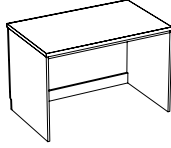

MCD-48D

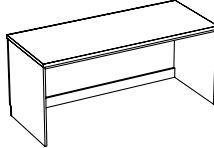

MCD-72D

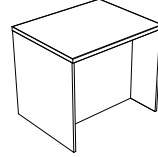

MCD-36D-32-ADA

Cupboard Units

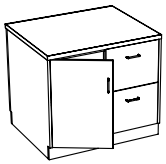

MCD-36C2D



MCD-36C3D

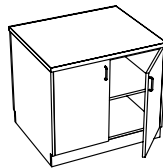

MCD-36CS

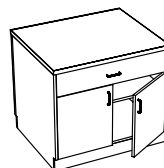

MCD-36CD

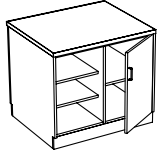

MCD-36COS

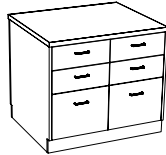

MCD-36C6D

Open Storage Units



MCD-36OSD

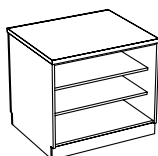

MCD-36OS

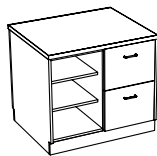

MCD-36OS2D

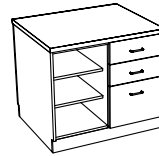

MCD-36OS3D

Corner Units

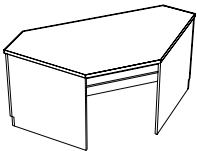

MCD-30EFC

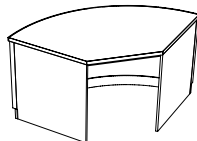

MCD-30ERC

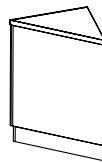

MCD-30FC45

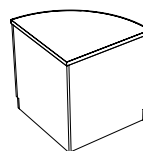

MCD-30RC

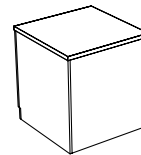

MCD-30SC

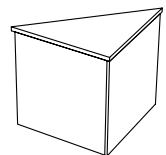

MCD-30TC

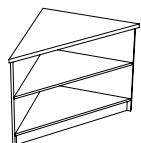

MCD-30TCS

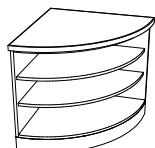

MCD-30RCS

Transaction Tops



MCD-36-TRX



MCD-72-TRX

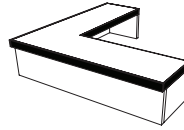

MCD-30SC-TRX



MCD-30RC-TRX



MCD-30EFC-TRX



MCD-30ERC-TRX

Terminating End Panel

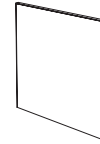

MCD-B-29EP

Book Return Units

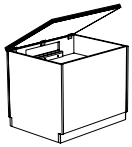

MCD-36SBR

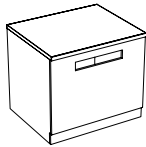

MCD-36BR

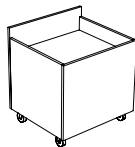

MCD-22DBT

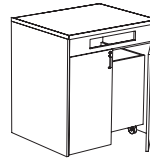

36CBR



36SBR-TOP

Pedestals



WMP661222



WHP661222



MCD-18CS

Kneespace Units

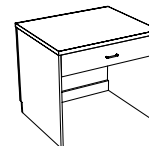

MCD-36KS

Options

- Continuous tops may be specified.
- Locking mechanisms may be specified with doors and/or drawers locking, keyed random or alike.
- Desk unit lengths are available in other lengths to meet specific project needs.
- Kneespace panels
- Terminating end panels are required for each exposed end of a complete desk assembly.
- Pencils drawers available with steel front.

See mediatechnologies finish and color guide for finish choices.

- To specify a design line you must include a letter indicator: no letter indicator will specify our standard Bookmark design.

Required Item: Circulation Desk

Proposed Line: Bookmark

Additional Lines: Keystone, Malibu, Lexington, Metro

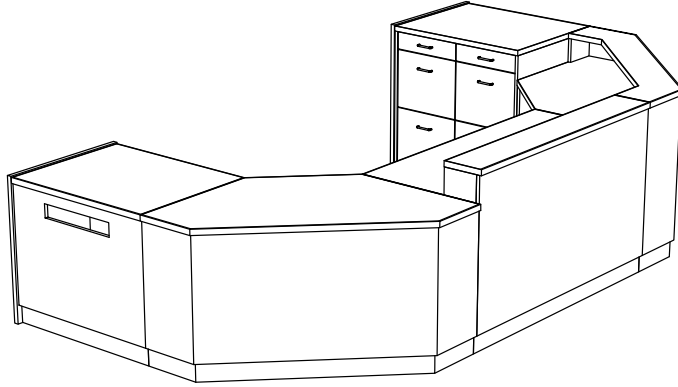

Model Numbers shown are for Bookmark Modular Circulation Desk Components

- For Keystone add KS (i.e. MCD-KS-36D-29)
- For Malibu add MB (i.e. MCD-MB-36D-29)
- For Lexington add L (i.e. MCD-L-36D-29)
- For Metro add M (i.e. MCD-M-36D-29)

Desk Units

36" Wide

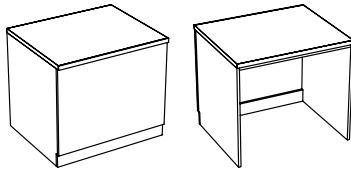

Model Number	Description	Wt.
MCD-36D-29	Desk Unit, 36"W X 30"D X 29" H	116
MCD-36D-32	Desk Unit, 36"W X 30"D X 32" H	122
MCD-36D-32-ADA	ADA Desk Unit, 36"W X 30"D X 32"H	122
MCD-36D-39	Desk Unit, 36"W X 30"D X 39" H	137
MCD-36D-32-ADJ	Desk Unit, 36"W X 30"D X ADJ. H	122

48" Wide

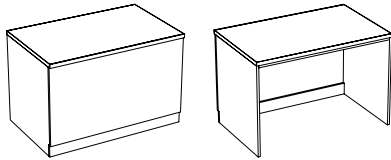

Model Number	Description	Wt.
MCD-48D-29	Desk Unit, 48"W X 30"D X 29" H	127
MCD-48D-32	Desk Unit, 48"W X 30"D X 32" H	134
MCD-48D-39	Desk Unit, 48"W X 30"D X 39" H	149
MCD-48D-32-ADJ	Desk Unit, 48"W X 30"D X ADJ. H	134

72" Wide

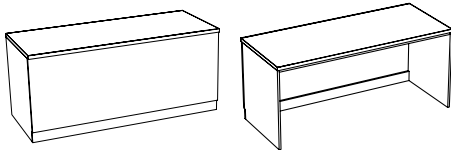

Model Number	Description	Wt.
MCD-72D-29	Desk Unit, 72"W X 30"D X 29" H	201
MCD-72D-32	Desk Unit, 72"W X 30"D X 32" H	208
MCD-72D-39	Desk Unit, 72"W X 30"D X 39" H	226
MCD-72D-32-ADJ	Desk Unit, 72"W X 30"D X ADJ. H	208

Note: Desk units are available in other lengths to meet specific project needs. Please inquire.

Book Return Module

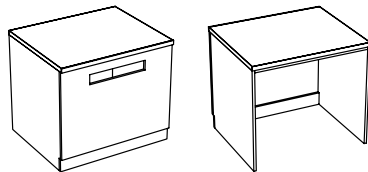

Model Number	Description	Wt.
MCD-36BR-29	Book Return, 36"W X 30"D X 29" H	115
MCD-36BR-32	Book Return, 36"W X 30"D X 32" H	121
MCD-36BR-39	Book Return, 36"W X 30"D X 39" H	136

Descending Platform Book Truck

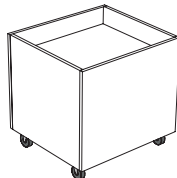

Model Number	Description	Wt.
MCD-DBT-1824-21	Depressible Platform Book Truck, 18"D x 24.25"W x 21"H, For curved 29"H Book Return Units and Nomad Book Return	135
MCD-DBT-1824-24	Depressible Platform Book Truck, 18"D x 24.25"W x 24"H, For Curved 32"-39"H Book Return Units	135
MCD-DBT-2424-21	Depressible Platform Book Truck, 23.625"D x 24.25"W x 21"H, For 29"H Book Return Units with Extended Chutes and 32"H Keystone and Malibu Book Returns	137
MCD-DBT-2424-24	Depressible Platform Book Truck, 23.625"D x 24.25"W x 24"H, For 32" and #("H Book Return Units	137

Stand-Alone Book Return and Descending Book Truck



Model Number	Description	Wt.
MCD-36CBB/DBT-48	Book Return, 36"W X 30"D X 48" H and Book Truck 22" D X 26" W X 28"	252

Front Panel Slot Book Return Module with Descending Platform

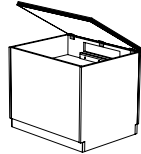

Model Number	Description	Wt.
MCD-S36BR-32	Book Return w Front Panel Slot & Descending Platform, 36"W X 30"D X 32" H	195
MCD-S36BR-39	Book Return w Front Panel Slot & Descending Platform, 36"W X 30"D X 39" H	210

Top Surface Slot Book Return Module with Drawer and Shelf Storage



Model Number	Description	Wt.
MCD-36SBR-TOP-29	Book Return w Top Slot, 36"W X 30"D X 29" H	198
MCD-36SBR-TOP-32	Book Return w Top Slot, 36"W X 30"D X 32" H	201
MCD-36SBR-TOP-39	Book Return w Top Slot, 36"W X 30"D X 39" H	215

Drawer Units



Model Number	Description	Wt.
MCD-36-4D-29	Drawer Unit, 36"W X 30"D X 29" H with 4 drawers	240
MCD-36-4D-32	Drawer Unit, 36"W X 30"D X 32" H with 4 drawers	245
MCD-36-6D-32	Drawer Unit, 36"W X 30"D X 32" H with 6 drawers	250
MCD-36-6D-39	Drawer Unit, 36"W X 30"D X 39" H with 6 drawers	284

Cupboard Units

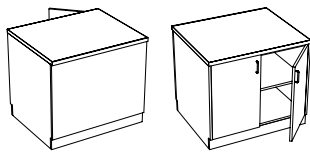

Model Number	Description	Wt.
MCD-36CS-29	Cupboard Unit, 36"W X 30"D X 29" H	187
MCD-36CS-32	Cupboard Unit, 36"W X 30"D X 32" H	190
MCD-36CS-39	Cupboard Unit, 36"W X 30"D X 39" H	208

Cupboard Unit With Drawer

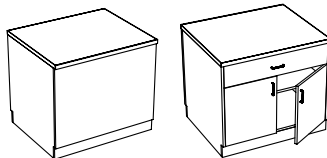

Model Number	Description	Wt.
MCD-36CD-29	Cupboard Unit, 36"W X 30"D X 29" H with drawer	199
MCD-36CD-32	Cupboard Unit, 36"W X 30"D X 32" H with drawer	205
MCD-36CD-39	Cupboard Unit, 36"W X 30"D X 39" H with drawer	223

Cupboard Unit With 2 & 3 Drawers (Cupboard Left)

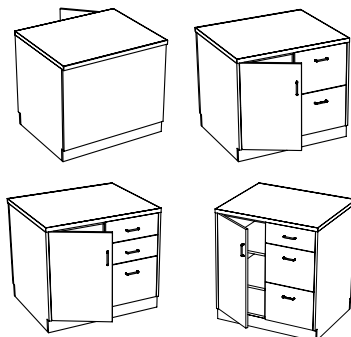

Model Number	Description	Wt.
MCD-36C2DL-29	Cupboard Unit, Left, 36"W X 30"D X 29" H with 2 drawers, file/file	220
MCD-36C2DL-32	Cupboard Unit, Left, 36"W X 30"D X 32" H with 2 drawers, file/file	223
MCD-36C3DL-32	Cupboard Unit, Left, 36"W X 30"D X 32" H with 3 drawers, box/box/file	228
MCD-36C3DL-39	Cupboard Unit, Left, 36"W X 30"D X 39" H with 3 drawers, box/file/file	254

Drawers in these units accommodate standard hanging files.

Required Item: Circulation Desk

Proposed Line: Bookmark

Additional Lines: Keystone, Malibu, Lexington, Metro

Cupboard Unit With 2 & 3 Drawers (Cupboard Right)

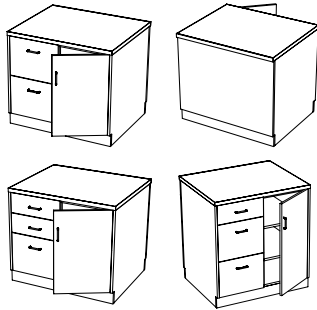

Model Number	Description	Wt.
MCD-36C2DR-29	Cupboard Unit, Right, 36"W X 30"D X 29" H with 2 drawers, file/file	220
MCD-36C2DR-32	Cupboard Unit, Right, 36"W X 30"D X 32" H with 2 drawers, file/file	223
MCD-36C3DR-32	Cupboard Unit, Right, 36"W X 30"D X 32" H with 3 drawers, box/box/file	228
MCD-36C3DR-39	Cupboard Unit, Right, 36"W X 30"D X 39" H with 3 drawers, box/file/file	254

Drawers in these units accommodate standard hanging files.

Cupboard Unit With Open Storage (Cupboard Left)

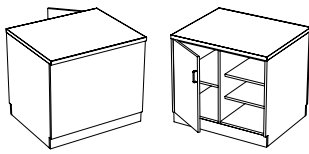

Model Number	Description	Wt.
MCD-36C0SL-29	Cupboard Unit, Left, 36"W X 30"D X 29" H with open storage	184
MCD-36C0SL-32	Cupboard Unit, Left, 36"W X 30"D X 32" H with open storage	188
MCD-36C0SL-39	Cupboard Unit, Left, 36"W X 30"D X 39" H with open storage	202

Cupboard Unit With Open Storage (Cupboard Right)

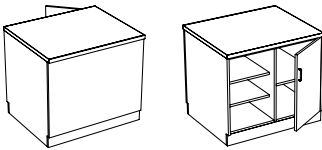

Model Number	Description	Wt.
MCD-36C0SR-29	Cupboard Unit, Right, 36"W X 30"D X 29" H with open storage	184
MCD-36C0SR-32	Cupboard Unit, Right, 36"W X 30"D X 32" H with open storage	188
MCD-36C0SR-39	Cupboard Unit, Right, 36"W X 30"D X 39" H with open storage	202

Open Storage Units

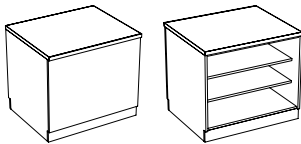

Model Number	Description	Wt.
MCD-36OS-29	Open Storage, 36"W X 30"D X 29" H	183
MCD-36OS-32	Open Storage, 36"W X 30"D X 32" H	186
MCD-36OS-39	Open Storage, 36"W X 30"D X 39" H	200

Open Storage Unit With Drawer

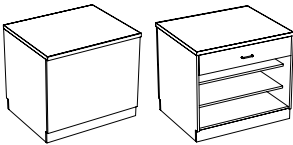

Model Number	Description	Wt.
MCD-36OSD-29	Open Storage, 36"W X 30"D X 29" H with drawer	198
MCD-36OSD-32	Open Storage, 36"W X 30"D X 32" H with drawer	201
MCD-36OSD-39	Open Storage, 36"W X 30"D X 39" H with drawer	215

Open Storage Unit With 2 & 3 Drawers (Open Storage Left)

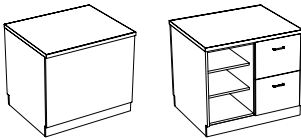

Model Number	Description	Wt.
MCD-36OS2DL-29	Open Storage, Left, 36"W X 30"D X 29" H with 2 drawers, file/file	207
MCD-36OS2DL-32	Open Storage, Left, 36"W X 30"D X 32" H with 2 drawers, file/file	210
MCD-36OS3DL-32	Open Storage, Left, 36"W X 30"D X 32" H with 3 drawers, box/box/file	218
MCD-36OS3DL-39	Open Storage, Left, 36"W X 30"D X 39" H with 3 drawers, box/file/file	238

Open Storage Unit With 2 & 3 Drawers (Open Storage Right)

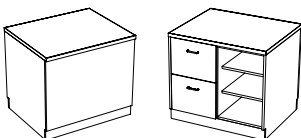

Model Number	Description	Wt.
MCD-36OS2DR-29	Open Storage, Right, 36"W X 30"D X 29" H with 2 drawers, file/file	207
MCD-36OS2DR-32	Open Storage, Right, 36"W X 30"D X 32" H with 2 drawers, file/file	210
MCD-36OS3DR-32	Open Storage, Right, 36"W X 30"D X 32" H with 3 drawers, box/box/file	218
MCD-36OS3DR-39	Open Storage, Right, 36"W X 30"D X 39" H with 3 drawers, box/file/file	238

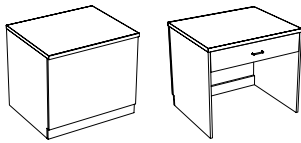
Kneespace Unit

Model Number	Description	Wt.
MCD-36KS-32	Kneespace Unit, 36"W X 30"D X 32" H	136
MCD-36KS-39	Kneespace Unit, 36"W X 30"D X 39" H	149

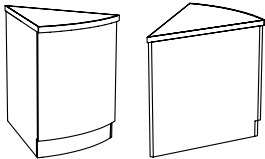
Corner Units**45 Degree 30" Radius**

Model Number	Description	Wt.
MCD-30RC45-29	Radius Corner, 30"W X 30"D X 29" H	74
MCD-30RC45-32	Radius Corner, 30"W X 30"D X 32" H	77
MCD-30RC45-39	Radius Corner, 30"W X 30"D X 39" H	84

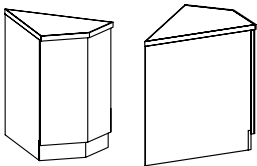
45 Degree Flat

Model Number	Description	Wt.
MCD-30FC45-29	Flat Corner, 30"W X 30"D X 29" H	74
MCD-30FC45-32	Flat Corner, 30"W X 30"D X 32" H	77
MCD-30FC45-39	Flat Corner, 30"W X 30"D X 39" H	84

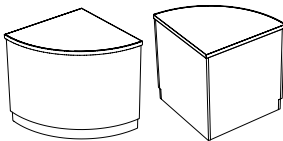
90 Degree 30" Radius

Model Number	Description	Wt.
MCD-30RC-29	Radius Corner, 30"W X 30"D X 29" H	148
MCD-30RC-32	Radius Corner, 30"W X 30"D X 32" H	153
MCD-30RC-39	Radius Corner, 30"W X 30"D X 39" H	168

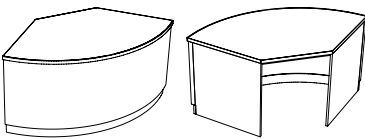
90 Degree Extended 46" Radius

Model Number	Description	Wt.
MCD-30ERC-29	Radius Ext. Corner, 66"W X 30"D X 29" H	276
MCD-30ERC-32	Radius Ext. Corner, 66"W X 30"D X 32" H	284
MCD-30ERC-39	Radius Ext. Corner, 66"W X 30"D X 39" H	306

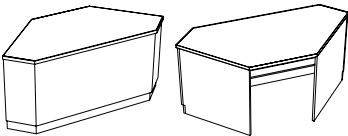
90 Degree Extended 66" Wide Flat

Model Number	Description	Wt.
MCD-30EFC-29	Flat Ext. Corner, 66"W X 30"D X 29" H	164
MCD-30EFC-32	Flat Ext. Corner, 66"W X 30"D X 32" H	173
MCD-30EFC-39	Flat Ext. Corner, 66"W X 30"D X 39" H	190

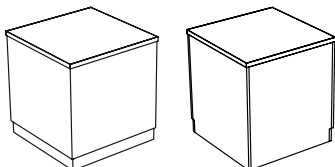
90 Degree Square

Model Number	Description	Wt.
MCD-30SC-29	Square Corner, 30"W X 30"D X 29"H	150
MCD-30SC-32	Square Corner, 30"W X 30"D X 32"H	155
MCD-30SC-39	Square Corner, 30"W X 30"D X 39"H	170

Required Item: Circulation Desk

Proposed Line: Bookmark

Additional Lines: Keystone, Malibu, Lexington, Metro

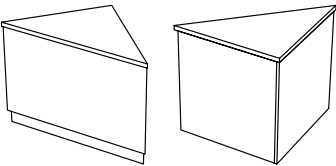
Triangle Corner Unit	Model Number	Description	Wt.
	MCD-30TC-29	Triangle Corner, 30"W X 30"D X 29" H	87
	MCD-30TC-32	Triangle Corner, 30"W X 30"D X 32" H	89
	MCD-30TC-39	Triangle Corner, 30"W X 30"D X 39" H	97

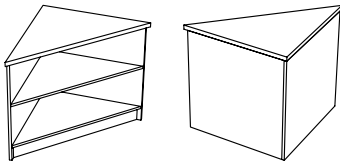
Triangle Corner Unit with Shelves	Model Number	Description	Wt.
	MCD-30TCS-29	Triangle Corner, 30"W X 30"D X 29" H with shelves	85
	MCD-30TCS-32	Triangle Corner, 30"W X 30"D X 32" H with shelves	87
	MCD-30TCS-39	Triangle Corner, 30"W X 30"D X 39" H with shelves	95

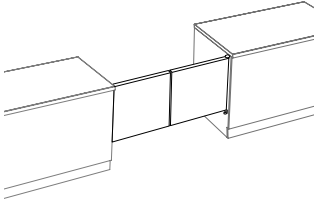
Double Action Gate	Model Number	Description	Wt.
	MCD-GATE-32	Double Action Gate for 32"H Modules, 36"W x 1"D x 26"H	24
	MCD-GATE-39	Double Action Gate for 39"H Modules, 36"W x 1"D x 33"H	28

Note: One Terminating End Panel is required for each exposed end of a complete desk assembly. End Panels are available in all standard design lines. Terminating end panels are available to create right or left facing units. Right side and left side is determined from the perspective of the desk user.

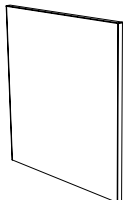
Bookmark	Model Number	Description	Wt.
	MCD-B-29-EP-LH	Bookmark Finished End Panel for 29"H Unit, Left	18
	MCD-B-29-EP-RH	Bookmark Finished End Panel for 29"H Unit, Right	18
	MCD-B-32-EP-LH	Bookmark Finished End Panel for 32"H Unit, Left	19
	MCD-B-32-EP-RH	Bookmark Finished End Panel for 32"H Unit, Right	19
	MCD-B-39-EP-LH	Bookmark Finished End Panel for 39"H Unit, Left	23
	MCD-B-39-EP-RH	Bookmark Finished End Panel for 39"H Unit, Right	23

Transactions Tops

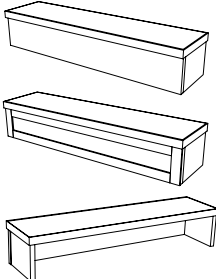
Transactions Tops	Model Number	Description	Wt.
	MCD-36-TRX	Bookmark Transaction Top 36"W X 7"H	18
	MCD-CL-36-TRX	Charleston Transaction Top 36"W X 7"H	18
	MCD-H-36-TRX	Heritage Transaction Top 36"W X 7"H	19
	MCD-KS-36-TRX	Keystone Transaction Top 36"W X 7"H	19
	MCD-L-36-TRX	Lexington Transaction Top 36"W X 7"H	19
	MCD-MB-36-TRX	Malibu Transaction Top 36"W X 7"H	19

72" Transaction Tops

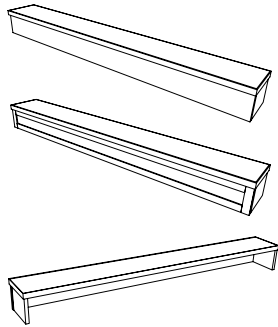

Model Number	Description	Wt.
MCD-72-TRX	Bookmark Transaction Top 72"W X 7"H	32
MCD-CL-72-TRX	Charleston Transaction Top 72"W X 7"H	32
MCD-H-72-TRX	Heritage Transaction Top 72"W X 7"H	33
MCD-KS-72-TRX	Keystone Transaction Top 72"W X 7"H	33
MCD-L-72-TRX	Lexington Transaction Top 72"W X 7"H	33
MCD-MB-72-TRX	Malibu Transaction Top 72"W X 7"H	33

Square Corner Transaction Tops

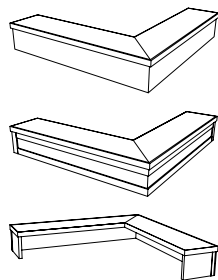

Model Number	Description	Wt.
MCD-30SC-TRX	Bookmark Transaction Top 9"D X 7"H	18
MCD-CL-30SC-TRX	Charleston Transaction Top 9"D X 7"H	18
MCD-H-30SC-TRX	Heritage Transaction Top Square Unit 9"D X 7"H	19
MCD-KS-30SC-TRX	Keystone Transaction Top for Square Unit 9"D X 7"H	19
MCD-L-30SC-TRX	Lexington Transaction Top 9"D X 7"H	19

90° Radius Corner Transaction Top

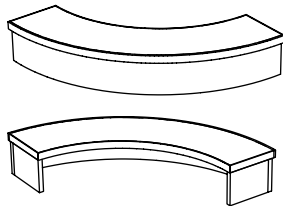

Model Number	Description	Wt.
MCD-30RC-TRX	Bookmark Transaction Top 9"D X 7"H	16
MCD-CL-30RC-TRX	Charleston Transaction Top 9"D X 7"H	16

Extended Flat Corner

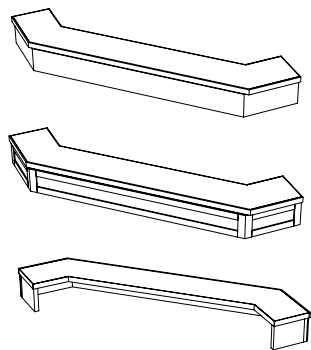

Model Number	Description	Wt.
MCD-30EFC-TRX	Bookmark Transaction Top 9"D X 7"H	29
MCD-CL-30EFC-TRX	Charleston Transaction Top 9"D X 7"H	29
MCD-H-30EFC-TRX	Heritage Transaction Top Extended Flat 9"D X 7"H	30
MCD-L-30EFC-TRX	Lexington Transaction Top 9"D X 7"H	29

Extended Radius Corner



Model Number	Description	Wt.
MCD-30ERC-TRX	Bookmark Transaction Top 9"D X 7"H	25

Required Item: Circulation Desk

Proposed Line: Bookmark

Additional Lines: Keystone, Malibu, Lexington, Metro

Mobile Pedestals



Model Number	Description	Wt.
WMP661222	6/6/12 X 22" D Mobile Pedestal, steel with steel fronts	42
WMP121222	12/12 X 22" D Mobile Pedestal, steel with steel fronts	38
WMP661222-SW	6/6/12 X 22" D Mobile Pedestal, steel with wood fronts	54
WMP121222-SW	12/12 X 22" D Mobile Pedestal, steel with wood fronts	50
WMP661222-W	6/6/12 X 22" D Mobile Pedestal, wood with wood fronts	66
WMP121222-W	12/12 X 22" D Mobile Pedestal, wood with wood fronts	62

WKS Supporting Pedestals

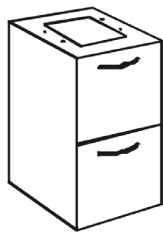

Model Number	Description	Wt.
WP661222	6/6/12 X 22" D WKS Supporting Ped, steel with steel fronts	46
WP121222	12/12 X 22" D WKS Supporting Ped, steel with steel fronts	42
WP661222-SW	6/6/12 X 22" D WKS Supporting Ped, steel with wood fronts	58
WP121222-SW	12/12 X 22" D WKS Supporting Ped, steel with wood fronts	62
WP661222-W	6/6/12 X 22" D WKS Supporting Ped, wood with wood fronts	69
WP121222-W	12/12 X 22" D WKS Supporting Ped, wood with wood fronts	65





Bookmark Media Carrels

- Starter/Adder construction allows for larger groupings.
- Panels are available in Oak or Maple veneer.
- Grommets are standard.
- Post & Panel version are fitted with adjustable glides.
- Work surface is high pressure laminate.

Work Surface Height: 29"
Overall Height: 48"
Starter Widths: 36-7/8", 50-3/8"
Adder Widths: 35-7/8", 49-3/8"



Power it up!
Connectivity options available.



BPP2836SSC

PANEL END



BPE2836SSC
Single-Face Starter



BPE2836SSCA
Single-Face Adder



BPE2836DSC
Dual-Face Starter



BPE2836DSCA
Dual-Face Adder



BPE2836QC
Quad Carrel



RSC0060-BM-PE
Radius Carrel Worksurface

POST & PANEL END



BPP2848SSC
Single-Face Starter



BPP2848SSCA
Single-Face Adder



BPP2848DSC
Dual-Face Starter



BPP2848DSCA
Dual-Face Adder



BPP2836QC
Quad Carrel



RSC0060-BM-PP
Radius Carrel Worksurface

General Specifications - Panel End Carrels

Worksurfaces: 1-1/4" thick, three ply engineered wood construction with .050" high pressure laminate and a phenolic backer sheet. The front edge is 5/8" x 1-5/8" solid red oak with either **B**; a 1/2" radius top and bottom, or **BB**; a 1/2" bevel top and bottom. Worksurfaces are attached to the side and back panels with (3) steel brackets. Grommet (s) come standard.

End / Intermediate Panels: Intermediate panels are 1-3/16" thick, three ply engineered wood with select red oak veneers on both sides. The panels are banded with 1/8" solid red oak on the top, bottom and front edge. Panels are attached to each other with Mod-eez fasteners. Each panel is equipped with an adjustable glide.

Worksurface Height: Standard worksurface height is 29". Other heights are available at no additional charge. To specify adjustable height: Add -ADJ to model number.

Panel, Overall Carrel Height: Standard carrel height is 48". 32" to 48" heights are available. To specify: Add to model number with **P** suffix (i.e. BPP2836QC-32P).

Modular Design: mediatechnologies® carrels may be disassembled and reconfigure. Adder units are similar to initial units but substitute one intermediate panel for two end panels.

Edge Treatments: **B** for Bookmark Standard, **BB** for Bookmark Bevel

Specify: Model Number / Edge / Wood Finish / Laminate / Height / Arrangement

Single Faced Panel End Carrels

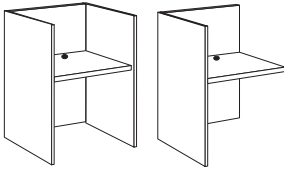

Model Number	Description	Wt.
BPE2836SSC	Initial carrel, 31"D X 36-7/8"W X 48"H	200
BPE2848SSC	Initial carrel, 31"D X 50-3/8"W X 48"H	233
BPE2836SSCA	Adder carrel, 31"D X 35-7/8"W X 48"H	151
BPE2848SSCA	Adder carrel, 31"D X 49-3/8"W X 48"H	184

Double Faced

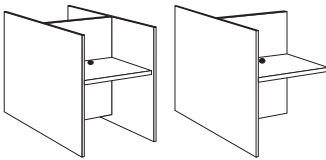

Model Number	Description	Wt.
BPE2836DSC	Initial carrel, 60"D X 36-7/8"W X 48"H	343
BPE2848DSC	Initial carrel, 60"D X 50-3/8"W X 48"H	389
BPE2836DSCA	Adder carrel, 60"D X 35-7/8"W X 48"H	244
BPE2848DSCA	Adder carrel, 60"D X 49-3/8"W X 48"H	290

Radius Worksurface

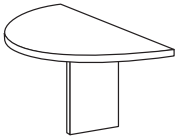

Model Number	Description	Wt.
RCS0060-BM-PE	Radius Carrel Worksurface 57-1/4" Diameter half round with panel support leg.	62

Quad Carrels

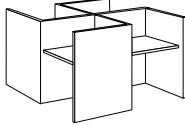

Model Number	Description	Wt.
BPE2836QC	Quad carrel, 72"D X 72"W X 48"H	641
BPE2848QC	Quad carrel, 99"D X 99"W X 48"H	850

Hex Carrels

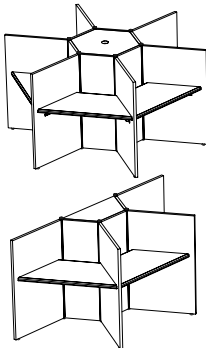

Model Number	Description	Wt.
B096HC	96" Diameter X 48" high full hex carrel	664
B120HC	120" Diameter X 48" high full hex carrel	890
B096HHC	96" Diameter X 48" high half hex carrel	425
B120HHC	120" Diameter X 48" high half hex carrel	577

Hex Lid: The hex lid is 1-1/4" thick three ply engineered wood construction with .050 HPL face and a phenolic backer sheet. The lid is supported by three metal brackets.

Power/Data: A USPCD power data module is fit into each back panel below the work surface. Each module has one interior and three exterior facing receptacles, a cat. 5 data jack and an on/off switch and provides power surge protection.

Required Item: Study/Listening/Computer Carrels or Stations

Proposed Line: Bookmark cont'd

General Specifications - Post and Panel Carrels

Worksurfaces: 1-1/4" thick, three ply engineered wood construction with .050" high pressure laminate and a phenolic backer sheet. The front edge is 5/8" x 1-5/8" solid red oak with either **B**; a 1/2" radius top and bottom, or **BB**; a 1/2" bevel top and bottom. Worksurfaces are attached to the side and back panels with (3) steel brackets. Grommet (s) come standard.

Legs: Legs are 1-5/8" solid glued up red oak and pre-drilled to receive shoulder screws. Each leg is equipped with an adjustable glide.

End / Intermediate / Back Panels: Panels are 1", nine ply hardwood plywood with select red oak veneers on both faces. The top and bottom edges are banded with 1/8" solid red oak. Each panel is joined to a leg using Mod-eez fasteners.

Worksurface Height: Standard worksurface height is 29" Other heights are available at no additional charge. **To specify adjustable height:** Add **-ADJ** to model number.

Panel, Overall Carrel Height: Standard carrel height is 48". 32" to 48" heights are available. **To specify:** Add to model number with **P** suffix (i.e. BPP2836QC-32P).

Modular Design: mediatechnologies® carrels may be disassembled and reconfigure. Adder units are similar to initial units but substitute one intermediate panel for two end panels.

Edge Treatments: **B** for Bookmark Standard, **BB** for Bookmark Bevel

Single Faced Post & Panel Carrels

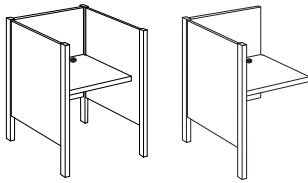

Model Number	Description	Wt.
BPP2836SSC	Initial carrel, 31"D X 36-7/8"W X 48"H	113
BPP2848SSC	Initial carrel, 31"D X 50-3/8"W X 48"H	134
BPP2836SSCA	Adder carrel, 31"D X 35-7/8"W X 48"H	89
BPP2848SSCA	Adder carrel, 31"D X 49-3/8"W X 48"H	109

Double Faced

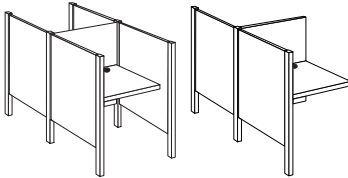

Model Number	Description	Wt.
BPP2836DSC	Initial carrel, 60"D X 36-7/8"W X 48"H	200
BPP2848DSC	Initial carrel, 60"D X 50-3/8"W X 48"H	234
BPP2836DSCA	Adder carrel, 60"D X 35-7/8"W X 48"H	153
BPP2848DSCA	Adder carrel, 60"D X 49-3/8"W X 48"H	187

The RCS has the same edge detail as the carrel tops and is supported by a Bookmark table leg. Mounts along side of double sided carrel; intended for end-of-run applications. Grommet available please include a layout with order.

Radius Worksurface

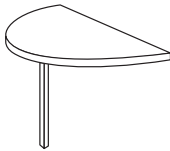

Model Number	Description	Wt.
RCS0060-BM-PP	Radius Carrel Worksurface 57-1/4" Diameter half round with Bookmark support leg.	58

Quad Carrels

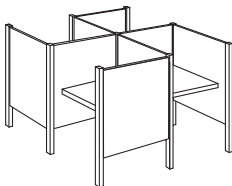

Model Number	Description	Wt.
BPP2836QC	Quad carrel, 72"D X 72"W X 48"H	370
BPP2848QC	Quad carrel, 99"D X 99"W X 48"H	479

Required Item: Study/Listening/Computer Carrels or Stations

Additional Line: GTX Carrel



Required Item: Study/Listening/Computer Carrels or Stations

Additional Line: Cabana



GTX Carrel Table

Key Features

- Engineered wood construction with high pressure laminate faces and PVC banding
- Welded frame constructed of 14-gauge powder coated square steel tube
- Adjustable glides
- Single-faced and double faced models available.

Cabana

Key Features

- Panels are 1-1/4" engineered wood construction with high pressure laminate faces and PVC banding
- Side shelf and work surface are 1-1/4" engineered wood construction with high pressure laminate face, a phenolic backer and PVC banding
- Adjustable glides
- Seat is NOT included.
- Work surface height is 29" Side Shelf height is 16"

GTX Carrel Tables		
Single-Faced		
Model Number	Top Dimensions	Wt.
GTXSCT-C2436-29	24"D X 36"W	73
GTXSCT-C2460-29	24"D X 60"W	97
GTXSCT-C2472-29	24"D X 72"W	109
GTXSCT-C3036-29	30"D X 36"W	83
GTXSCT-C3060-29	30"D X 60"W	110
GTXSCT-C3072-29	30"D X 72"W	124
Double-Faced		
Model Number	Top Dimensions	Wt.
GTXDCT-C4836-29	48"D X 36"W	133
GTXDCT-C4860-29	48"D X 60"W	173
GTXDCT-C4872-29	48"D X 72"W	197
GTXDCT-C6036-29	60"D X 36"W	153
GTXDCT-C6060-29	60"D X 60"W	199
GTXDCT-C6072-29	60"D X 72"W	227

Carrels are face-to-face with a privacy panel between

Cabana		
High Pressure laminate, PVC Edgebanding		
Model Number	Description	Wt.
CAB-C3844LR	Cabana Privacy Cubicle, 38"D x 44"W x 48"H, Right Facing, Starter	250
CAB-C3844LRA	Cabana Privacy Cubicle, 38"D x 43"W x 48"H, Right Facing, Adder	171
CAB-C3844LL	Cabana Privacy Cubicle, 38"D x 44"W x 48"H, Left Facing, Starter	250
CAB-C3844LLA	Cabana Privacy Cubicle, 38"D x 43"W x 48"H, Left Facing, Adder	171
CAB-C3884L	Cabana Double-wide Privacy Cubicle, 38"D x 84"W x 48"H, Starter	
CAB-C3884LA	Cabana Double-wide Privacy Cubicle, 38"D x 83"W x 48"H, Adder	
CAB-C3884DFL	Cabana Double-Faced, Double-wide Privacy Cubicle, 38"D x 84"W x 48"H, Starter	
CAB-C3884DFLA	Cabana Double-Faced, Double-wide Privacy Cubicle, 38"D x 83"W x 48"H, Adder	
CAB-SH12L	Cabana side shelf, 12"D x 36"W x 1"thick, PVC Edge	



Required Item:

Lounge Furniture: Sofa, Loveseat, Chairs and Matching Occasional Tables

Proposed Line: Engage Seating



ENAW-3035-18



ENATR-2529-4C

Tablet arm
available on
left or right!

Handle is standard
when unit is ordered
with casters.

Engage

Key Features

- Fully upholstered seat and back are constructed on a hardwood frame, and covered with 1.8 density upholstery foam.
- Upholstery fabric available in Grades 1 - 9
- Steel leg with adjustable glide is standard. Also available with wooden post leg and swivel casters.

Engage

Model Number	Base	Seat/ Back	Seat Ht.	Arms	Wt.	COM Yd.
EN-3029-(grade)-4S	4 Metal					
EN-3029-(grade)-2S	2 Metal, 2 Casters					
EN-3029-(grade)-4W	4 Wood	Uph	18"	Right & Left	53	5
EN-3029-(grade)-2W	2 Wood, 2 Casters					
EN-3029-(grade)-4C	4 Casters					
ENL-2829-(grade)-4S	4 Metal					
ENL-2829-(grade)-2S	2 Metal, 2 Casters					
ENL-2829-(grade)-4W	4 Wood	Uph	18"	Left	45	3.75
ENL-2829-(grade)-2W	2 Wood, 2 Casters					
ENL-2829-(grade)-4C	4 Casters					
ENR-2829-(grade)-4S	4 Metal					
ENR-2829-(grade)-2S	2 Metal, 2 Casters					
ENR-2829-(grade)-4W	4 Wood	Uph	18"	Right	45	3.75
ENR-2829-(grade)-2W	2 Wood, 2 Casters					
ENR-2829-(grade)-4C	4 Casters					
ENA-2529-(grade)-4S	4 Metal					
ENA-2529-(grade)-2S	2 Metal, 2 Casters					
ENA-2529-(grade)-4W	4 Wood	Uph	18"	No	34	2.5
ENA-2529-(grade)-2W	2 Wood, 2 Casters					
ENA-2529-(grade)-4C	4 Casters					
ENATL-2529-(grade)-4S	4 Metal					
ENATL-2529-(grade)-2S	2 Metal, 2 Casters					
ENATL-2529-(grade)-4W	4 Wood	Uph	18"	Tablet Arm, Left	34	2.5
ENATL-2529-(grade)-2W	2 Wood, 2 Casters					
ENATL-2529-(grade)-4C	4 Casters					

Model Number	Base	Seat/ Back	Seat Ht.	Arms	Wt.	COM Yd.
ENATR-2529-(grade)-4S	4 Metal					
ENATR-2529-(grade)-2S	2 Metal, 2 Casters					
ENATR-2529-(grade)-4W	4 Wood	Uph	18"	Tablet Arm, Right	34	2.5
ENATR-2529-(grade)-2W	2 Wood, 2 Casters					
ENATR-2529-(grade)-4C	4 Casters					
ENAW-3035-(grade)-4S	4 Metal					
ENAW-3035-(grade)-2S	2 Metal, 2 Casters					
ENAW-3035-(grade)-4W	4 Wood	Uph	18"	No	34	3
ENAW-3035-(grade)-2W	2 Wood, 2 Casters					
ENAW-3035-(grade)-4C	4 Casters					
EN-5329-(grade)-4S	4 Metal					
EN-5329-(grade)-2S	2 Metal, 2 Casters					
EN-5329-(grade)-4W	4 Wood	Uph	18"	Right & Left	75	7
EN-5329-(grade)-2W	2 Wood, 2 Casters					
EN-5329-(grade)-4C	4 Casters					
ENL-5129-(grade)-4S	4 Metal					
ENL-5129-(grade)-2S	2 Metal, 2 Casters					
ENL-5129-(grade)-4W	4 Wood	Uph	18"	Left	65	5.75
ENL-5129-(grade)-2W	2 Wood, 2 Casters					
ENL-5129-(grade)-4C	4 Casters					
ENR-5129-(grade)-4S	4 Metal					
ENR-5129-(grade)-2S	2 Metal, 2 Casters					
ENR-5129-(grade)-4W	4 Wood	Uph	18"	Right	65	5.75
ENR-5129-(grade)-2W	2 Wood, 2 Casters					
ENR-5129-(grade)-4C	4 Casters					
ENA-4829-(grade)-4S	4 Metal					
ENA-4829-(grade)-2S	2 Metal, 2 Casters					
ENA-4829-(grade)-4W	4 Wood	Uph	18"	No	56	4.5
ENA-4829-(grade)-2W	2 Wood, 2 Casters					
ENA-4829-(grade)-4C	4 Casters					



ENR-2829-18



ENL-2829-18



EN-3029-18



ENAW-3035-18



EN-5329-18



ENR-5129-18



ENL-5129-18



ENA-4829-18



Required Item:

Lounge Furniture: Sofa, Loveseat, Chairs and Matching Occasional Tables

Additional Line: Fulltime Ottomans



FTC-60
24" Return x 54"W



FTC-30
24" Return x 28"W

Fulltime Ottomans

Key Features

- Fully upholstered seat is constructed on an engineered wood frame, and covered with high density upholstery foam.
- Upholstery fabric available in Grades 1 - 9
- Steel leg with adjustable glide is standard, Also available with wooden post leg, swivel casters and 16"H versions with self adjusting glides.

66

Round

Model Number	Base	Seat	Diameter "	Seat Ht. "	Wt.	COM Yd.
FTD-20-5S	Steel Post	Uph	20	18	64	1.5
FTD-20-5C	Casters	Uph	20	18	64	1.5
FTD-20-4W	Wood	Uph	20	18	64	1.5
FTD-30-5S	Steel Post	Uph	30	18	84	2.5
FTD-30-5C	Casters	Uph	30	18	84	2.5
FTD-30-5W	Wood	Uph	30	18	84	2.5
FTD-36-5S	Steel Post	Uph	36	18	96	2.5
FTD-36-5C	Casters	Uph	36	18	96	2.5
FTD-36-5W	Wood	Uph	36	18	96	2.5
FTD-51-5S	Steel Post	Uph	51	18	132	3.5
FTD-51-5C	Casters	Uph	51	18	132	3.5
FTD-51-5W	Wood	Uph	51	18	132	3.5

Round Junior

FTDJ-20	Self-Leveling Glide	Uph	20	16	64	1.5
FTDJ-30	Self-Leveling Glide	Uph	30	16	84	2.5
FTDJ-36	Self-Leveling Glide	Uph	36	16	96	2.5
FTDJ-51	Self-Leveling Glide	Uph	51	16	132	3.5

Crescent

Model Number	Base	Seat	Diameter "	Seat Ht. "	Wt.	COM Yd.
SCO-0020-18-5S	Steel Post	Uph	20	18	60	1.5
SCO-0020-18-5C	Casters	Uph	20	18	60	1.5
SCO-0020-18-5W	Wood	Uph	20	18	60	1.5
SCO-0030-18-5S	Steel Post	Uph	30	18	90	2.5
SCO-0030-18-5C	Casters	Uph	30	18	90	2.5
SCO-0030-18-5W	Wood	Uph	30	18	90	2.5
SCO-0036-18-5S	Steel Post	Uph	36	18	108	2.5
SCO-0036-18-5C	Casters	Uph	36	18	108	2.5
SCO-0036-18-5W	Wood	Uph	36	18	108	2.5
SCO-0051-18-5S	Steel Post	Uph	51	18	121	3.5
SCO-0051-18-5C	Casters	Uph	51	18	121	3.5
SCO-0051-18-5W	Wood	Uph	51	18	121	3.5

Crescent Junior

FTCOJ-0020	Self-Leveling Glide	Uph	20	16	60	1.5
FTCOJ-0030	Self-Leveling Glide	Uph	30	16	90	2.5
FTCOJ-0036	Self-Leveling Glide	Uph	36	16	108	2.5
FTCOJ-0051	Self-Leveling Glide	Uph	51	16	121	3.5

Half Round

Model Number	Base	Seat	Depth "	Width "	Seat Ht. "	Wt.	COM Yd.
FTHD-48-4S	Steel Post	Uph	24	48"	18	66	2.5
FTHD-48-4C	Casters	Uph	24	48"	18	66	2.5
FTHD-48-4W	Wood	Uph	24	48"	18	66	2.5

Half Round Junior

FTHDJ-48	Self-Leveling Glide	Uph	24	48"	16	66	2.5
----------	---------------------	-----	----	-----	----	----	-----

Curve

Model Number	Base	Seat	Return Depth "	Width "	Seat Ht. "	Wt.	COM Yd.
FTC-30-4S	Steel Post	Uph	24	28	18	69	1.5
FTC-30-4C	Casters	Uph	24	28	18	69	1.5
FTC-30-4W	Wood	Uph	24	28	18	69	1.5
FTC-60-4S	Steel Post	Uph	24	54	18	140	3
FTC-60-5C	Casters	Uph	24	54	18	140	3
FTC-60-5W	Wood	Uph	24	54	18	140	3
FTC-30-7224-4S	Steel Post	Uph	24	37.25	18	84	2
FTC-30-7224-4C	Casters	Uph	24	37.25	18	84	2
FTC-30-7224-4W	Wood	Uph	24	37.25	18	84	2
FTC-60-4221-DVS-4S	Steel Post	Uph	21"	41.75"	18	85	2
FTC-60-4221-DVS-5C	Casters	Uph	21"	41.75"	18	85	2
FTC-60-4221-DVS-5W	Wood	Uph	21"	41.75"	18	85	2

Curve Junior

FTCJ-30	Self-Leveling Glide	Uph	24	28	16	69	1.5
FTCJ-60	Self-Leveling Glide	Uph	24	54	16	140	3
FTCJ-30-7224	Self-Leveling Glide	Uph	24	37.25	16	84	2
FTCJ-60-4221-DVS	Self-Leveling Glide	Uph	21"	41.75"	16	85	2
FTCJ-60-4221-18-DVS	Self-Leveling Glide	Uph	21"	41.75"	18	85	2



FTHD-48
24"D x 48"W



FTS-2424
24"D x 24"W
36"D x 36"W



FTP-18
28"D x 30"W
37"D x 39"W



FTR-1836
18"D x 36"W
24"D x 36"W
24"D x 48"W



SCO-0051
20", 30", 36", 51"
Diameters



FTD-51
20", 36", 51"
Diameters

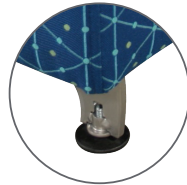

Standard Steel Leg



Caster

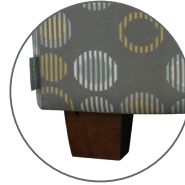

Oak Post Leg



Jr. Glides for 16"H

Pentagon

Model Number	Base	Seat	Depth "	Width "	Seat Ht. "	Wt.	COM Yd.
FTP-18-5S	Steel Post	Uph	28	30	18	63	1.75
FTP-18-5C	Casters	Uph	28	30	18	63	1.75
FTP-18-5W	Wood	Uph	28	30	18	63	1.75
FTP-24-5S	Steel Post	Uph	37"	39"	18	84	2.5
FTP-24-5C	Casters	Uph	37"	39"	18	84	2.5
FTP-24-5W	Wood	Uph	37"	39"	18	84	2.5

Pentagon Junior

FTPJ-18	Self-Leveling Glide	Uph	28	30	16	63	1.75
FTPJ-24	Self-Leveling Glide	Uph	37"	39"	16	84	2.5

Square

Model Number	Base	Seat	Depth "	Width "	Seat Ht. "	Wt.	COM Yd.
FTS-2424-4S	Steel Post	Uph	24	24	18	60	1.75
FTS-2424-4C	Casters	Uph	24	24	18	60	1.75
FTS-2424-4W	Wood	Uph	24	24	18	60	1.75
FTS-3636-4S	Steel Post	Uph	36	36	18	89	2.25
FTS-3636-4C	Casters	Uph	36	36	18	89	2.25
FTS-3636-4W	Wood	Uph	36	36	18	89	2.25

Square Junior

FTSJ-2424	Self-Leveling Glide	Uph	24	24	16	60	1.75
FTSJ-3636	Self-Leveling Glide	Uph	36	36	16	89	2.25

Rectangle

Model Number	Base	Seat	Depth "	Width "	Seat Ht. "	Wt.	COM Yd.
FTR-1836-4S	Steel Post	Uph	18	36	18	55	1.75
FTR-1836-4C	Casters	Uph	18	36	18	55	1.75
FTR-1836-4W	Wood	Uph	18	36	18	55	1.75
FTR-2436-4S	Steel Post	Uph	24	36	18	72	1.75
FTR-2436-4C	Casters	Uph	24	36	18	72	1.75
FTR-2436-4W	Wood	Uph	24	36	18	72	1.75
FTR-2448-4S	Steel Post	Uph	24	48"	18	80	2
FTR-2448-4C	Casters	Uph	24	48"	18	80	2
FTR-2448-4W	Wood	Uph	24	48"	18	80	2

Rectangle Junior

FTRJ-1836	Self-Leveling Glide	Uph	18	36	16	55	1.75
FTRJ-2436	Self-Leveling Glide	Uph	24	36	16	72	1.75
FTRJ-2448	Self-Leveling Glide	Uph	24	48"	16	80	2



Full Time Crescents with Full Time Ottable

Required Item:

Lounge Furniture: Sofa, Loveseat, Chairs and Matching Occasional Tables

Additional Line: Fulltime Halfbacks



FTSB2-2424-4S



FTRB2-2460



FTCBV2-60



FTCBX2-60



Fulltime Halfback

Key Features

- Fully upholstered seat and back are constructed on an engineered wood frame, and covered with high density upholstery foam.
- Back joined with seat with steel rods.
- Upholstery fabric available in Grades 1 - 9
- Powder coated steel leg with adjustable glide is standard, Also available with wooden post leg, swivel casters and 16"H versions with self adjusting glides.

68

Halfback Square

Model Number	Base	Seat & Back	Depth"	Width"	Seat Ht."	OA Ht."	Wt.	COM Yd.
FTSB2-2424-4S	Steel Post	Uph	24	24	18	33	55	2.5
FTSB2-2424-4C	Casters	Uph	24	24	18	33	55	2.5
FTSB2-2424-4W	Wood	Uph	24	24	18	33	55	2.5

Halfback Square Junior

FTSB2J-2424	Self-leveling Glide	Uph	24	24	16	31	55	2.5
-------------	---------------------	-----	----	----	----	----	----	-----

Halfback Rectangle

Model Number	Base	Seat	Depth"	Width"	Seat Ht."	OA Ht."	Wt.	COM Yd.
FTRB2-2436-4S	Steel Post	Uph	24	36	18	33	55	3.25
FTRB2-2436-4C	Casters	Uph	24	36	18	33	55	3.25
FTRB2-2436-4W	Wood	Uph	24	36	18	33	55	3.25
FTRB2-2448-4S	Steel Post	Uph	24	48	18	33	75	4
FTRB2-2448-4C	Casters	Uph	24	48	18	33	75	4
FTRB2-2448-4W	Wood	Uph	24	48	18	33	75	4
FTRB2-2460-4S	Steel Post	Uph	24	60	18	33	100	5
FTRB2-2460-4C	Casters	Uph	24	60	18	33	100	5
FTRB2-2460-4W	Wood	Uph	24	60	18	33	100	5

Halfback Rectangle Junior

FTRB2J-2436	Self-leveling Glide	Uph	24	36	16	31	55	3.25
FTRB2J-2448	Self-leveling Glide	Uph	24	48	16	31	75	4
FTRB2J-2460	Self-leveling Glide	Uph	24	60	16	31	100	5

Halfback 60-degree Curve (Seating on Concave side)

Model Number	Base	Seat	Curve	OA Width"	Seat Ht."	OA Ht."	Wt.	COM Yd.
FTCBV2-60-5S	Steel Post	Uph	60	54	18	33	160	5
FTCBV2-60-5C	Casters	Uph	60	54	18	33	160	5
FTCBV2-60-5W	Wood	Uph	60	54	18	33	160	5
FTCBV2-60-7224-5S	Steel Post	Uph	60	72	18	33	180	5
FTCBV2-60-7224-5C	Casters	Uph	60	72	18	33	180	5
FTCBV2-60-7224-5W	Wood	Uph	60	72	18	33	180	5

Halfback 60-degree Curve Junior Seating on Concave side)

FTCBV2J-60	Self-leveling Glide	Uph	60	54	16	31	160	5
FTCBV2J-60-7224	Self-leveling Glide	Uph	60	72	16	31	180	5

Halfback 60-degree Curve (Seating on Convex side)

Model Number	Base	Seat	Curve	OA Width"	Seat Ht."	OA Ht."	Wt.	COM Yd.
FTCBX2-60-5S	Steel Post	Uph	60	54	18	33	160	5
FTCBX2-60-5C	Casters	Uph	60	54	18	33	160	5
FTCBX2-60-5W	Wood	Uph	60	54	18	33	160	5
FTCBX2-60-7224-5S	Steel Post	Uph	60	72	18	33	180	5
FTCBX2-60-7224-5C	Casters	Uph	60	72	18	33	180	5
FTCBX2-60-7224-5W	Wood	Uph	60	72	18	33	180	5

Halfback 60-degree Curve Junior (Seating on Convex side)

FTCBX2J-60	Self-leveling Glide	Uph	60	54	16	31	160	5
FTCBX2J-60-7224	Self-leveling Glide	Uph	60	72	16	31	180	5

Required Item:

Lounge Furniture: Sofa, Loveseat, Chairs and Matching Occasional Tables

Additional Line: Wink



WNK-3030



WNK-6030



WNK-60-723



WNK-30-7230



WNK-60-7230-G7-MFD

Wink

Key Features

- Fully upholstered seat and back are constructed on an engineered wood frame, and covered with high density upholstery foam.
- Back and seat frames bolted together.
- Upholstery fabric available in Grades 1 - 9
- Self adjusting glides.

Wink Curve

Model Number	Base	Curve	Seat	Back	Seat Ht."	Wt.	COM Yd.
WNK-30-7230	Self-leveling glides	30 degree	Uph	Uph	18	34	3.5
WNK-60-7230	Self-leveling glides	60 degree	Uph	Uph	18	68	6.5

Wink Faceted Curve

WNK-60-7230-MFD	Self-leveling glides	60 degree	Uph	Uph	18	68	6.5
-----------------	----------------------	-----------	-----	-----	----	----	-----

Wink Straight

Model Number	Base	OA Width"	Seat	Back	Seat Ht."	Wt.	COM Yd.
WNK-3030	Self-leveling glides	30	Uph	Uph	18	34	3
WNK-6030	Self-leveling glides	60	Uph	Uph	18	68	5.5

Required Item:

Lounge Furniture: Sofa, Loveseat, Chairs and Matching Occasional Tables

Proposed Line: Bookmark Occasional Tables



B2424T-18

Bookmark Occasional Table

Key Features

- Top is engineered wood with high-pressure laminate work surface and phenolic backer with hardwood banding
- Legs are solid glued up oak equipped with a leveling glide
- Meets BIFMA Standards

Bookmark Occasional Tables

Model Number	Description	Wt.
Square Tables		
B2424T-A-18	24"W x 24"D x 18"H	38
B2424T-A-22	24"W x 24"D x 22"H	38
B3030T-A-18	30"W x 30"D x 18"H	42
B3030T-A-22	30"W x 30"D x 22"H	42

Rectangular Tables

B2448T-A-18	24"W x 48"D x 18"H	60
B2448T-A-22	24"W x 48"D x 22"H	60

Round Tables

B0030T-A-18	30" Diameter x 18"H	39
B0030T-A-22	30" Diameter x 22"H	39

Required Item:

Lounge Furniture: Sofa, Loveseat, Chairs and Matching Occasional Tables

Additional Line: Metro Occasional Tables



M2672T

Metro Occasional Table

Key Features

- Top is engineered wood with high-pressure laminate work surface and phenolic backer with hardwood banding
- Hardwood apron
- Legs are solid glued up oak equipped with a leveling glide
- Meets BIFMA Standards

Metro Occasional Tables

Model Number	Description	Wt.
Square Tables		
M2424T-18	24"W x 24"D x 18"H	38
M2424T-22	24"W x 24"D x 22"H	38
M3030T-18	30"W x 30"D x 18"H	35
M3030T-22	30"W x 30"D x 22"H	42

Rectangular Tables

M2448T-18	24"W x 48"D x 18"H	60
M2448T-22	24"W x 48"D x 22"H	60

Round Tables

M0030T-18	30" Diameter x 18"H	39
M0030T-22	30" Diameter x 22"H	39
M0036T-18	36" Diameter x 18"H	39
M0036T-22	36" Diameter x 22"H	39



Required Item:

Lounge Furniture: Sofa, Loveseat, Chairs and Matching Occasional Tables

Additional Line: Lexington Occasional Tables



L2424T-18

Lexington Occasional Table

Key Features

- Top is engineered wood with high-pressure laminate work surface and phenolic backer with hardwood banding
- Hardwood apron
- Legs are solid glued up oak equipped with a leveling glide
- Meets BIFMA Standards

Lexington Occasional Tables		
Model Number	Description	Wt.
Square Tables		
L2424T-18	24"W x 24"D x 18"H	38
L2424T-22	24"W x 24"D x 22"H	38
L3030T-18	30"W x 30"D x 18"H	42
L3030T-22	30"W x 30"D x 22"H	42
Rectangular Tables		
L2448T-18	24"W x 48"D x 18"H	60
L2448T-22	24"W x 48"D x 22"H	60
Round Tables		
L0030T-18	30" Diameter x 18"H	39
L0030T-22	30" Diameter x 22"H	39

Required Item:

Lounge Furniture: Sofa, Loveseat, Chairs and Matching Occasional Tables

Additional Line: Cesar Occasional Tables



CX26-C0030-18

Cesar Occasional Table

Key Features

- Top is engineered wood with high pressure laminate work surface and phenolic backer
- X-base legs are powder coated steel with aluminum feet
- Feet are fitted with adjustable glides
- Casters are available

Cesar Occasional Tables		
Model Number	Description	Wt.
Square		
CX20-C2424-18	Cesar Occasional table, 24" x 24" x 18"H	103
CX20-C2424-22	Cesar Occasional table, 24" x 24" x 22"H	103
CX26-C3030-18	Cesar Occasional table, 30" x 30" x 18"H	103
CX26-C3030-22	Cesar Occasional table, 30" x 30" x 22"H	103
Square with Radiused Corners		
CX20-C2424R-18	Cesar Occasional table, 24" x 24" x 18"H	103
CX20-C2424R-22	Cesar Occasional table, 24" x 24" x 22"H	103
CX26-C3030R-18	Cesar Occasional table, 30" x 30" x 18"H	103
CX26-C3030R-22	Cesar Occasional table, 30" x 30" x 22"H	103
Round		
CX20-C0030-18	Cesar Occasional table, 30" dia x 18"H	103
CX26-C0030-22	Cesar Occasional table, 30" dia x 22"H	103



Required Item:

Lounge Furniture: Sofa, Loveseat, Chairs and Matching Occasional Tables

Additional Line: Orbit Occasional Tables



O22-C0030-16

Orbit Occasional Table

Key Features

- Top is engineered wood with high pressure laminate work surface, phenolic backer and PVC banding
- Powder coated steel 17" Disc base is fitted with leveling glides



Square

Orbit Occasional Tables		
Model Number	Description	Wt.
Square Tables - Square Corners		
017-C2424-16	24"W x 24"D x 16"H	103
017-C3030-16	30"W x 30"D x 16"H	103
Square Tables - Radiused Corners		
017-C2424R-16	24"W x 24"D x 16"H	103
017-C3030R-16	30"W x 30"D x 16"H	103

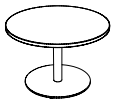

Round

Round Tables		
Model Number	Description	Wt.
017-C0030-16	30" Diameter x 16"H	103

Required Item:

Lounge Furniture: Sofa, Loveseat, Chairs and Matching Occasional Tables

Additional Line: Vector Occasional Tables



VT-C2424-22

Vector Occasional Table

Key Features

- Top is engineered wood with high pressure laminate work surface, phenolic backer and PVC banding
- Leg frames are powder coated steel and are fitted with adjustable glides



Square

Vector Occasional Tables		
Model Number	Description	Wt.
3mm PVC Edges		
Square Tables		
VT-C2424-18	24"W x 24"D x 18"H	38
VT-C2424-22	24"W x 24"D x 22"H	38
VT-C3030-18	30"W x 30"D x 18"H	42
VT-C3030-22	30"W x 30"D x 22"H	42



Rectangle

Rectangular Tables		
Model Number	Description	Wt.
VT-C2448-18	24"W x 48"D x 18"H	60
VT-C2448-22	24"W x 48"D x 22"H	60



Round

Round Tables		
Model Number	Description	Wt.
VT-C0030-18	30" Diameter x 18"H	39
VT-C0030-22	30" Diameter x 22"H	39

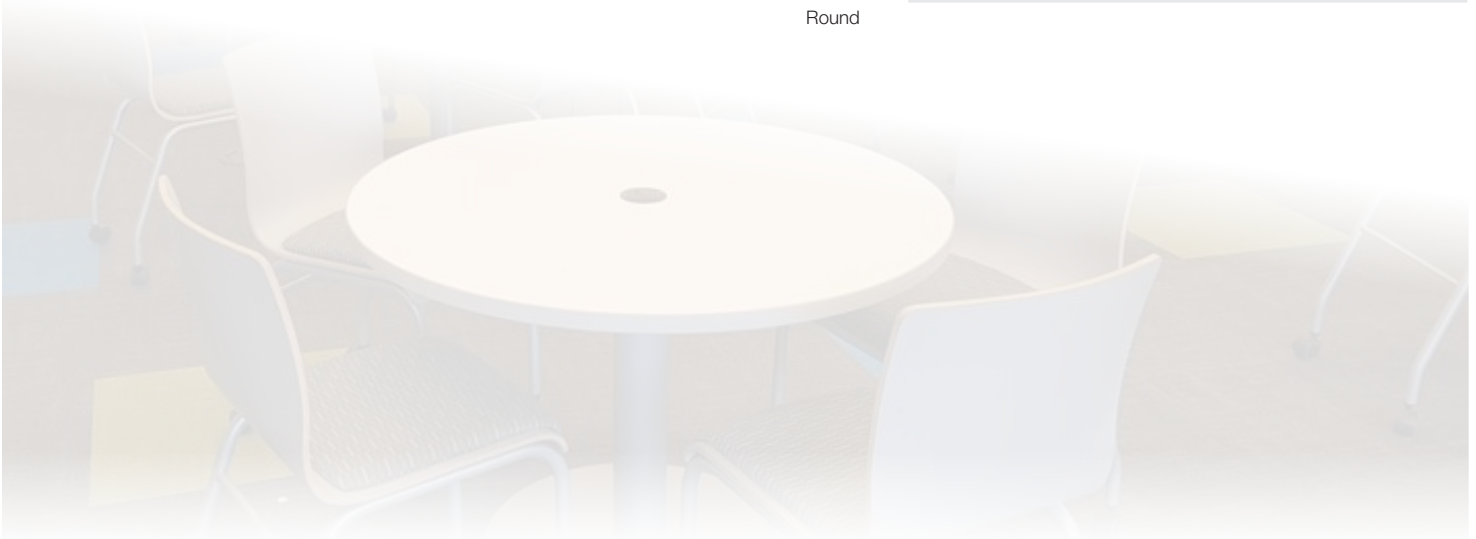

Required Item: Children's Library Furniture Tables and Chairs

Proposed Line: Bookmark Juvenile Chairs



BM-16D

Bookmark Juvenile Chairs

Key Features

- Solid oak chair frame
- Rear post legs are steam bent and extend from floor to top of back
- All wood seat is saddled. upholstered seat uses a hardwood frame with spring-suspended support mesh and high density foam cushion
- Upholstery fabric is available from Grade 1 thru 9
- All chairs meet BIFMA standards

Bookmark Juvenile Chairs

Model Number	Seat Ht.	Seat Depth	Seat Width	Overall Ht.	Overall Depth	Overall Width	Wt.	COM Yd.
BM-16A	16"	13.5"	16.25"	28.75"	17"	16"	22	N/A
BM-16B	16"	13.5"	16.25"	28.75"	17"	16"	22	1/2
BM-16C	16"	13.5"	16.25"	28.75"	17"	16"	22	2/3
BM-16D	16"	13.5"	16.25"	28.75"	17"	16"	22	7/8



BM-16A



BM-16B



BM-16C



BM-16D

Bookmark Juvenile Sled Base

Model Number	Seat Ht.	Seat Dpth.	Seat Width	Overall Ht.	Overall Depth	Overall Width	Wt.	COM Yd.
BM-SB16A	16"	13.5"	16.25"	28.75"	17"	16"	23	N/A
BM-SB16B	16"	13.5"	16.25"	28.75"	17"	16"	23	1/2
BM-SB16C	16"	13.5"	16.25"	28.75"	17"	16"	23	2/3
BM-SB16D	16"	13.5"	16.25"	28.75"	17"	16"	23	7/8



BM-SB16A



BM-SB16B



BM-SB16C



BM-SB16D

Required Item: Children's Library Furniture Tables and Chairs

Additional Line: Bola Children's Chairs



BOL-R45015



BOL-R45001

Bola Children's Chairs

Key Features

- Thermoplastic seat and back
- Upholstered Seat and back is urethane foam over molded plywood
- Upholstery Fabric is available in grades 1 thru 9
- Powder coated steel tube frame
- Molded nylon ball glides
- All chairs meet BIFMA standards



BOL-R45513



BOL-R45501

Bola, Junior, Fixed Back, Stacker, Armless

Model Number	Seat Material	Back Material	OA Ht."	OA Width"	OA Depth"	Seat Ht."	Wt.	Com Yd.
BOL-R45013	Plastic	Plastic	24	18	19	13	11	N/A
BOL-R45001-	Upholstery	Upholstery	24	18	19	13.5	11	0.75

Bola, Junior, Backless, Stacker, Armless

Model Number	Seat Material	Back Material	OA Ht."	OA Width"	OA Depth"	Seat Ht."	Wt.	Com Yd.
BOL-R45513	Plastic	N/A	13	18	19	13	10	N/A
BOL-R45501-	Upholstery	N/A	13.5	18	19	13.5	10	0.4

Bola, Teen, Fixed Back, Stacker, Armless

Model Number	Seat Material	Back Material	OA Ht."	OA Width"	OA Depth"	Seat Ht."	Wt.	Com Yd.
BOL-R45015	Plastic	Plastic	28.5	20.5	20.5	15	14	N/A
BOL-R45005-	Upholstery	Upholstery	28.5	20.5	20.5	15.5	14	1

Bola, Teen, Backless, Stacker, Armless

Model Number	Seat Material	Back Material	OA Ht."	OA Width"	OA Depth"	Seat Ht."	Wt.	Com Yd.
BOL-R45515	Plastic	N/A	15	20.5	20.5	15	13	N/A
BOL-R45505-	Upholstery	N/A	15.5	20.5	20.5	15.5	13	0.5

Bola, 4-wheel Dolly

Model Number	Height"	Width"	Depth"	Wt.	
R00005	Stacks 4	5.5	26	28	31

Required Item: Children's Library Furniture Tables and Chairs

Proposed Line: Bookmark Tables



B4242T-27

Bookmark Tables

Key Features

- High Pressure Laminate work surface with phenolic backer.
- Hardwood Legs, Apron and Banding.
- Available in juvenile height
- Unit is available in designer lines.
- For finishes refer to Mediatechnologies: Standard Finishes on Oak, Standard Finishes on Maple, Sprayon Finishes
- For Work surface laminate refer to Mediatechnologies: General Laminates
- All tables meet BIFMA standards

Bookmark Tables

Rectangle	Model Number	Description	Wt.
	B2436T-27	24"W X 36"L Table	54
	B2436T-27-A	24"W X 36"L Table with apron	61
	B3060T-27	30"W X 60"L Table	86
	B3060T-27-A	30"W X 60"L Table with apron	96
	B3072T-27	30"W X 72"L Table	98
	B3072T-27-A	30"W X 72"L Table with apron	110
	B3660T-27	36"W X 60"L Table	98
	B3660T-27-A	36"W X 60"L Table with apron	110
	B4260T-27	42"W X 60"L Table	111
	B4260T-27-A	42"W X 60"L Table with apron	123
	B4860T-27	48"W X 60"L Table	123
	B4860T-27-A	48"W X 60"L Table with apron	136
	B3672T-27	36"W X 72"L Table	113
	B3672T-27-A	36"W X 72"L Table with apron	126
	B4272T-27	42"W X 72"L Table	128
	B4272T-27-A	42"W X 72"L Table with apron	142
	B4872T-27	48"W X 72"L Table	143
	B4872T-27-A	48"W X 72"L Table with apron	157
	B3690T-27	36"W X 90"L Table	136
	B3690T-27-A	36"W X 90"L Table with apron	151
B4290T-27	42"W X 90"L Table	155	
B4290T-27-A	42"W X 90"L Table with apron	170	
B4890T-27	48"W X 90"L Table	173	
B4890T-27-A	48"W X 90"L Table with apron	190	

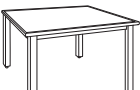
Square	Model Number	Description	Wt.
	B4242T-27	42"W X 42"L Table	85
	B4242T-27-A	42"W X 42"L Table with apron	95
	B4848T-27	48"W X 48"L Table	103
	B4848T-27-A	48"W X 48"L Table with apron	115

Round	Model Number	Description	Wt.
	B0042T-27	42" Diameter Table	76
	B0042T-27-A	42" Diameter Table with apron	83
	B0048T-27	48" Diameter Table	92
	B0048T-27-A	48" Diameter Table with apron	102

Required Item: Children's Library Furniture Tables and Chairs

Proposed Line: Bola Children's Tables



BOL-C4242SOR-21
Squirrel

Bola Children's Tables

Key Features

- Top is engineered wood with a high-pressure laminate work surface and phenolic backer with PVC banding
- legs are powder coated steel tube with nylon ball glide
- All tables meet BIFMA standards

Bola Children's Tables

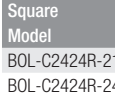
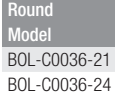
Rectangle	Model	Description	Wt.	
	BOL-C2442R-21	Bola, junior table, 24"D x 42"W x 21"H	43	
	BOL-C2442R-24	Bola, teen table, 24"D x 42"W x 24"H	44	
	BOL-C3042R-21	Bola, junior table, 30"D x 42"W x 21"H	51	
	BOL-C3042R-24	Bola, teen table, 30"D x 42"W x 24"H	52	
	BOL-C3048R-21	Bola, junior table, 30"D x 48"W x 21"H	57	
	BOL-C3048R-24	Bola, teen table, 30"D x 48"W x 24"H	58	
	BOL-C3060R-21	Bola, junior table, 30"D x 60"W x 21"H	73	
	BOL-C3060R-24	Bola, teen table, 30"D x 60"W x 24"H	74	
	BOL-C3648R-21	Bola, junior table, 36"D x 48"W x 21"H	71	
	BOL-C3648R-24	Bola, teen table, 36"D x 48"W x 24"H	72	
	BOL-C3660R-21	Bola, junior table, 36"D x 60"W x 21"H	88	
	BOL-C3660R-24	Bola, teen table, 36"D x 60"W x 24"H	89	
		BOL-C2424R-21	Bola, junior table, 24"D x 24"W x 21"H	27
		BOL-C2424R-24	Bola, teen table, 24"D x 24"W x 24"H	28
		BOL-C3030R-21	Bola, junior table, 30"D x 30"W x 21"H	38
		BOL-C3030R-24	Bola, teen table, 30"D x 30"W x 24"H	39
		BOL-C3636R-21	Bola, junior table, 36"D x 36"W x 21"H	52
		BOL-C3636R-24	Bola, teen table, 36"D x 36"W x 24"H	53
		BOL-C4242R-21	Bola, junior table, 42"D x 42"W x 21"H	72
		BOL-C4242R-24	Bola, teen table, 42"D x 42"W x 24"H	73
BOL-C4848R-21		Bola, junior table, 48"D x 48"W x 21"H	92	
BOL-C4848R-24		Bola, teen table, 48"D x 48"W x 24"H	93	
		BOL-C0036-21	Bola, junior table, 36" Dia x 21"H	43
		BOL-C0036-24	Bola, teen table, 36" Dia x 24"H	44
		BOL-C0042-21	Bola, junior table, 42" Dia x 21"H	52
		BOL-C0042-24	Bola, teen table, 42" Dia x 24"H	53
		BOL-C0048-21	Bola, junior table, 48" Dia x 21"H	75
		BOL-C0048-24	Bola, teen table, 48" Dia x 24"H	76
		BOL-C0054-21	Bola, junior table, 54" Dia x 21"H	94
		BOL-C0054-24	Bola, teen table, 54" Dia x 24"H	95



BOL-C3060R-29
Rectangle



BOL-C3636R-29
Square



BOL-C0036-29
Round



BOL-C4565RI-29
Raetsel



BOL-C3660FL-29
Flair



BOL-C4042-29
Pick



BOL-C3660BN-29
Beanie



BOL-C6060S-29
Sprocket

Squirele		
Model	Description	Wt.
BOL-C3636SQR-21	Bola, junior table, 36" x 36 x 21"H, 9" Radius corners	
BOL-C3636SQR-24	Bola, teen table, 36" x 36 x 24"H, 9" Radius corners	
BOL-C4242SQR-27	Bola, student table, 42" x 42" x 27"H, 10.5" Radius corners	
BOL-C4242SQR-29	Bola, table, 42" x 42" x 29"H, 10.5" Radius corners	
BOL-C4848SQR-27	Bola, student table, 48" x 48" x 27"H, 12" Radius corners	
BOL-C4848SQR-29	Bola, table, 48" x 48" x 29"H, 12" Radius corners	
BOL-C5454SQR-27	Bola, student table, 54" x 54" x 27"H, 13.5" Radius corners	
BOL-C5454SQR-29	Bola, table, 54" x 54" x 29"H, 13.5" Radius corners	
BOL-C6060SQR-27	Bola, student table, 60" x 60" x 27"H, 15" Radius corners	
BOL-C6060SQR-29	Bola, table, 60" x 60" x 29"H, 15" Radius corners	
Raetsel		
Model	Description	Wt.
BOL-C4565RL-21	Bola, junior table, 45"D x 65"W x 21"H	102
BOL-C4565RL-24	Bola, teen table, 45"D x 65"W x 24"H	103
Beanie		
Model	Description	Wt.
BOL-C3060BNR-21	Bola, junior table, 29.25"D x 58.375"W x 21"H	102
BOL-C3060BNR-24	Bola, teen table, 29.25"D x 58.375"W x 24"H	103
Flair		
Model	Description	Wt.
BOL-C3060FLR-21	Bola, junior table, 32.25"D x 59.5"W x 21"H	102
BOL-C3060FLR-24	Bola, teen table, 32.25"D x 59.5"W x 24"H	103
Sprocket		
Model	Description	Wt.
BOL-C6060S-21	Bola, junior table, 60"D x 60"W x 21"H	144
BOL-C6060S-24	Bola, teen table, 60"D x 60"W x 24"H	145
Pick		
Model	Description	Wt.
BOLP-C4042-21	Bola, junior table, 40"D x 42"W x 21"H	39
BOLP-C4042-24	Bola, teen table, 40"D x 42"W x 24"H	40



Required Item: Book Cart/Trucks

Proposed Line:

Bookmark Book Truck



BD-3016-BT

Required Item: Book Cart/Trucks

Proposed Line:

Bookmark Display Book Truck



BD-3018-BTD

Required Item: Book Cart/Trucks

Proposed Line:

Bookmark Steel Display Book Truck



SBD-3018-BTD

Bookmark Book Truck

Key Features

- 1" thick 9 ply oak veneer plywood construction
- Oak banding
- Finish in oak or maple veneer
- (2) 4" swivel and (2) 4" fixed casters

Bookmark Display Book Truck

Key Features

- 1" thick 9 ply oak veneer plywood construction
- Oak banding
- (2) shelves on each side with 6" backstop are tilted for display
- Finish in oak or maple veneer
- (2) 4" swivel and (2) 4" fixed casters

Bookmark Steel Display Book Truck

Key Features

- 1" thick solid oak end panels with eased edges
- (3) powder coated 18 gauge steel formed shelves on each side are tilted for display
- Finish in oak or maple veneer
- (4) 3" diameter swivel casters

Book Truck	Model Number	Description	Wt.
	BD-3016-BT	16" D X 34-1/2" W X 43" H	65

Display Book Truck	Model Number	Description	Wt.
	BD-3018-BTD	18" D X 34-1/2" W X 43" H	87

Steel Display Book Truck	Model Number	Description	Wt.
	SBD-3018-BTD	18" D x 34.5" W x 43" H	90

General Specifications

Constructed of 1" nine ply Red Oak veneer core plywood. Edges are banded with 1/8" Red Oak. All components are through-bolted using 1/4-20 cabinet bolts and embedded cross dowels for metal to metal joints. Book trucks use two 4" swivel and two 4" fixed casters for easy mobility.

General Specifications

Constructed of 1" nine ply Red Oak veneer core plywood. Edges are banded with 1/8" Red Oak. Two shelves on each side are tilted for display. Each shelf has a 6" high backstop. All components are through-bolted using 1/4-20 cabinet bolts and embedded cross dowels for metal to metal joints. Book trucks use two 4" swivel and two 4" fixed casters for easy mobility.

General Specifications

Unit is constructed of 1-1/2" solid oak end panels with eased edges. End panels receive twelve 5/16"-18 inserts. Unit includes three formed 18-gauge steel shelves formed to create two angled shelves for display. Shelves are mounted to end panels via eight 3/4" long 5/16"-18 bolts into the end panels. Shelves are finished with a durable powder coat. Standard powder coat color is black unless specified otherwise. The base of each end panel receives a formed steel "L" channel that is mounted to the end panel, which receives two 3" diameter casters.