



Hannah Seating

classroom • media center • cafeteria • office







media center



cafeteria



administration

HANNAH SEATING

Chairs



Armless Chair
HAN001
18"D x 18"W x



Arm Chair
HAN101



Mobile Armless Chair
HAN005



Mobile Arm Chair
HAN105

Counter Height Stools



Counter Stool
HAN008



Counter Stool w/ Arms
HAN108
*Shown with optional seat cushion

**Backpack storage models are available for all Counter & Café height stools.*

HANNAH SEATING

Café Height Stools



Cafe Stool HAN006



Cafe Stool w/ Arms
HAN106



Cafe Stool w/
Backpack Storage
HAN506

**Backpack storage models are available for all Counter & Café height stools.*

Task Stools



Swivel-Tilt Task Chair
HAN007



Swivel-Tilt Task Chair
w/ arms HAN107



Swivel-Tilt Task Stool
Foot-ring is height adjustable
HAN009



Swivel-Tilt Task Stool w/ Arms
Foot-ring is height adjustable
HAN109

Chairs & Stools Quick Guide

	Hannah
Base Style	
4 Post	•
Stacker	•
Glides	•
Mobile	•
Swivel-Tilt-Task	•
Heights	
Chair Height	•
Counter Stool Height	•
Café Stool Height	•
Features	
Arms	•
Armless	•
Book Rack	•
Storage Cart	•
Materials	
Thermoplastic	•
Upholstery	•
Powder Coat	•

Warranty

Hannah is backed by our limited lifetime warranty and has been designed with durability in mind to ensure it has a long and useful life. The following are a list of exceptions: functional parts are warranted for ten (10) years; casters are warranted for five (5) years and the upholstery material is warranted for three (3) years.

LEED

Contributing to LEED-CI V2.0*

MR 4.1 Recycled Content 10%
(post-consumer + post-industrial)

MR 4.2 Recycled Content 20%
(post-consumer + post-industrial)

MR 5.1 Local Manufacturing
IEQ 4.5 Low Emitting Materials

Pilot Credit 80 Environmentally Preferable
Interior Furnishings

Designers

Dennis Foley,
Jeffrey Gershune
& Chuck Saylor

PRODUCT PAIRINGS & KITS

Jane/Porter/Hannah Kit Products

- Ⓐ (1) Porter X-Base PX26-C29/34C-ADJPN-4C
- Ⓑ (1) Jane Desk JN3R-C3060L-29
- Ⓒ (1) Hannah Task Chair HAN007

Footprint as shown is
3'D x 7'W

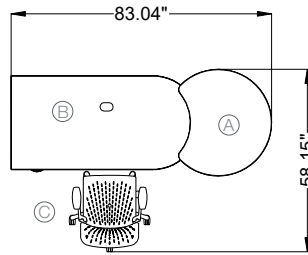
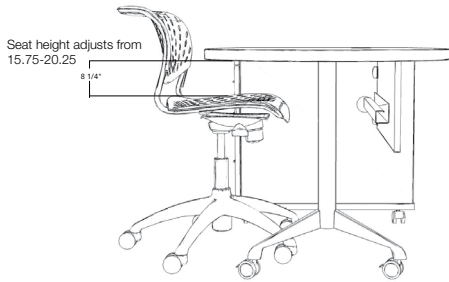

Rockford Crescents & Hannah Pairing

- Ⓐ (3) Rockford crescent tables RF-C3672CR
- Ⓑ (9) Hannah mobile stackers HAN005

Kit Footprint as Shown:
10.9' D X 10.4' W

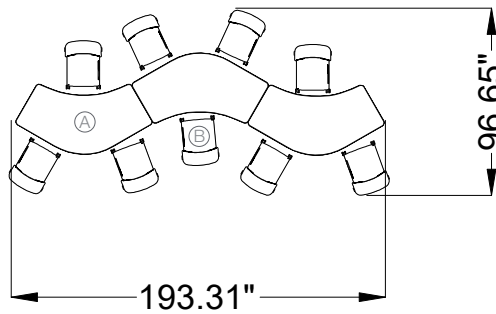
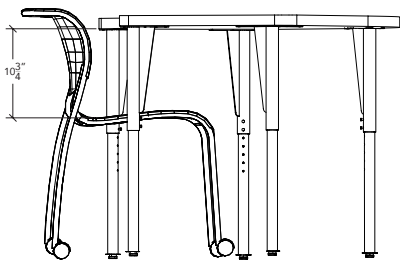

Wink/Indy Kit Products

- Ⓐ (2) Wink MFD 60-7230-MFD
- Ⓑ (1) Orbit Round Table O27-C0042-29
- Ⓒ (2) Full Time Round Ottomans FTD-20-5C
- Ⓓ (3) Hannah Stools HAN008

Kit Footprint as Shown:
10.9' D X 10.4' W

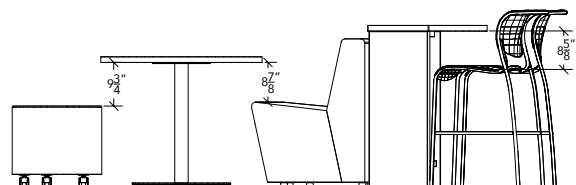
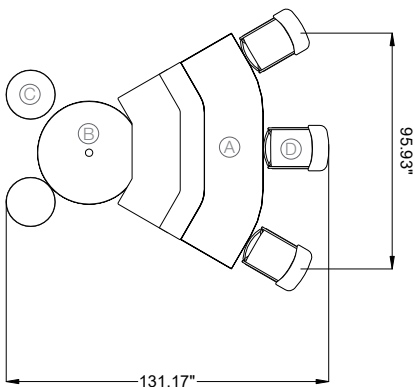

CUSTOMIZE COLORS!



Brand your products with custom colors for high impact and/or to match the tones of other materials used in your space.

We support custom options for polys (minimum 256), powder coats* (no minimum), and our mtcontract Sprayon** lacquer paint finishes (no minimum).

* Non-standard powder coats will incur an upcharge.

**Sprayons can be made to match any Pantone Color.



Features & Benefits:

- Stacker, mobile, swivel-tilt task chair, counter height stool café height stool, swivel-tilt task stool, book-bag shelf storage
- Pocket-posture comfort, rolled waterfall design allows the seat back to serve double-duty as an armrest or perch when standing (not suggested on mobile models)
- Meets or exceeds ANSI/BIFMA Standards 250lbs. + weight capacity
- Chair stacks 10 high on the floor or 16 high on mobile storage cart
- Upholstered seat cushion available and can be field installed or replaced
Note: *seat cushion adds 1" to the seat height

To Order Specify

8 Group I Frame Finishes: 809 Silver, 138 White, 109 Cream, 208 Putty, 304 Dove Grey, 407 Stone, 912 Black, 902 Black Wrinkle

11 Group II Frame Finishes (up-charge): 5003 Navy, 808 Nickel, 405 Charcoal, 621 Goldfinch, 622 Parakeet, 613 Blue Heron, 627 Blue Wren, 629 Hummingbird, 618 Purple Martin, 624 Cardinal

17 Thermoplastic (Polypropylene) Color Options: T16 Dove, T11, Swan, T15 Falcon, T12 Raven, T17 Woodpecker, T22 Parakeet, T19 Peacock, T29 Hummingbird, T13 Blue Heron, T27 Blue Wren, T18 Purple Martin, T21 Goldfinch, T23 Oriole, T24 Cardinal, T14 Jay*, T20 Macaw*, T28 Lorakeet*, T25 Flamingo *Limited Stock Available T30 Rio

Fabric and Colorway: Grade 1-9, COM. **Note:** Momentum; Silica, Silica Leather and Canter are not approved for use.

- Standard glides are nylon, non-marring glides in colors Raven or Falcon, Steel glides available
- HAN005 (mobile chairs) casters are white and grey
- Task Chair and Stool Casters are black, twin-wheel type for multiple floor surfaces. Bell Glides available for swivel-tilt task seating
- Task chair base color is black
- Arm rests are black
- Arm frames match seat frame

See MTContract's finish choices at <https://www.mtcontract.com/resources/finishes>

Model Number Breakdown:

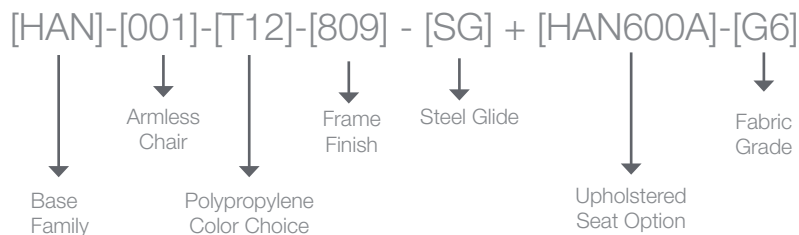

Hannah, Stacker, Armless. Thermoplastic 18D x 18W x 29.5H
Thermoplastic-T12 Raven, Powder coat-809 Silver
Steel Glides are not standard and must be designated in your order. They will incur an upcharge.

For Upholstered Hannah Seat you must order the desired polypropylene seat AND the Hannah Upholstered Seat Cushion (HAN600A) in the Grade you desire as separate items i.e.:
+ HAN600A-G6
Grade 6 Fabric: Mayer Acuco Poppy 445-001

Options



Upholstered Seat Cushion
HAN600A



White & Grey
caster for
4-leg chair



Black caster for
swivel-tilt task
seating



Nylon glides
Default is grey,
black is default
with black
frame finish



Steel glide
-SG



Bell glide for swivel-tilt
task seating
-BG



Storage Cart
HAN003