

# Full Time Ottomans, Halfbacks & Ottables

# Price Sheet 2023



# Full Time Ottomans, Halfbacks & Ottables

Ottomans are the appetizers of the lounge furniture menu. They are a perfect perch for an impromptu gathering, an individual time out space, or a casual strategy meeting. Moveable, reconfigurable, comfortable, colorful. Delicious on their own or combine them to create your own special entrée.

Today's spaces require both flexibility and durability. Simple, combinable shapes help to simplify space planning. Mobility options help to make flexibility easy and make user-reconfigurability a snap.

Constructed on a durable wood frame and wrapped and padded in comfort-oozing high density upholstery foam, Full Time Ottomans are ready to be finished in the upholstery of your choice. Select from our impressive array of graded fabric options or feel free to provide your own special fabric selection. Your full Time Ottomans will be performing and looking great for a long time

Full Time Ottomans are available in various sizes of the following easily configurable shapes for you to mix and match:

Round, Crescent, Half Round, Curve, Pentagon, Square and Rectangle

Like most families, the Full Time Ottoman family includes a few members that are a bit "different". **Full Time Ottables** are select Full Time Ottoman shapes with a table top! **Full Time Halfbacks** are select Full Time Ottomans that include a back. **Junior** versions (16" Height) are available for all.

## Options:

Full Time Ottomans and Halfbacks have surfaces that can be upholstered in fabric combinations.

Full Time Ottomans and Halfbacks are available with:

- powder coated plate steel legs with adjustable glides
- swivel casters
- oak post legs that you can have finished in one of our finish options.

A Power and Connectivity Option is available for flat vertical surfaces of Full Time Ottomans.

Full Time Ottables have a worksurface that is suitable for mounting many of our surface-mount connectivity options.



ROUND OTTOMANS

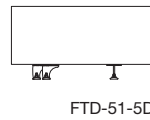
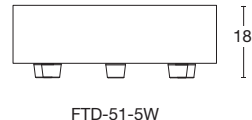
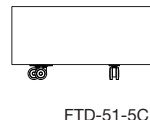
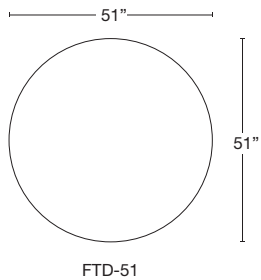
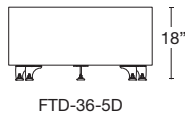
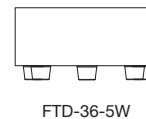
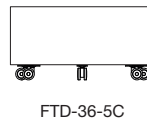
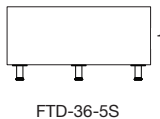
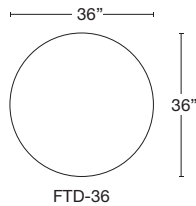
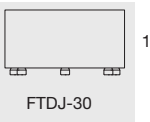
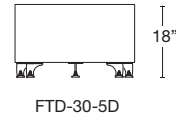
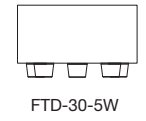
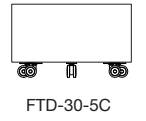
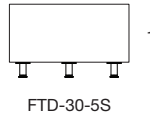
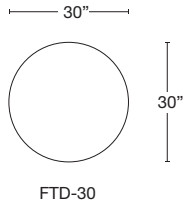
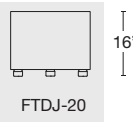
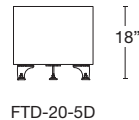
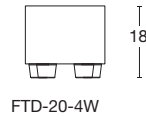
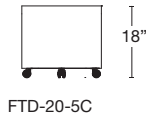
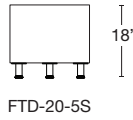
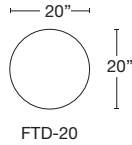
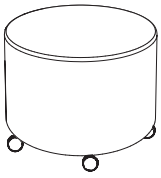

■ = Junior seat height 16"

HALF ROUND OTTOMANS

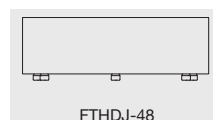
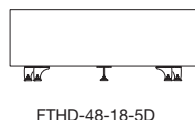
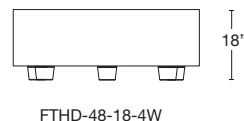
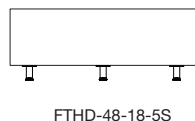
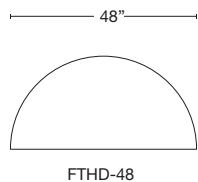
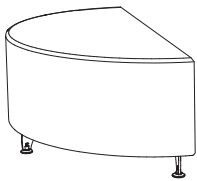

■ = Junior seat height 16"

CRESCENT OTTOMANS

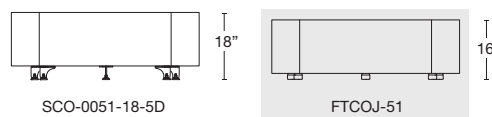
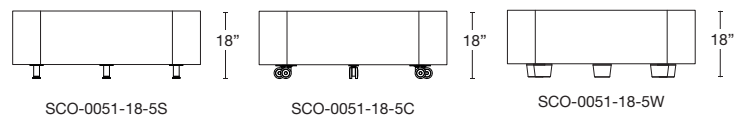
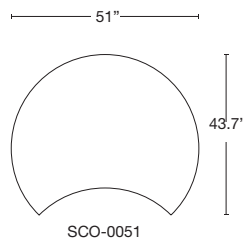
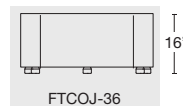
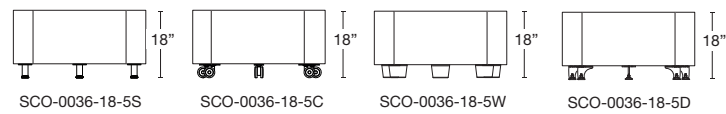
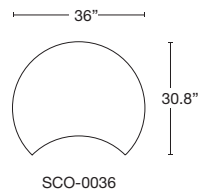
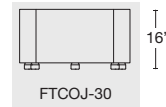
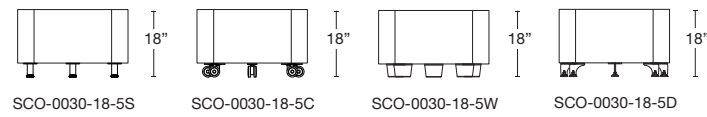
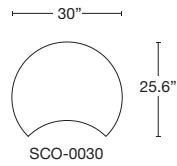
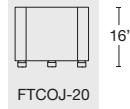
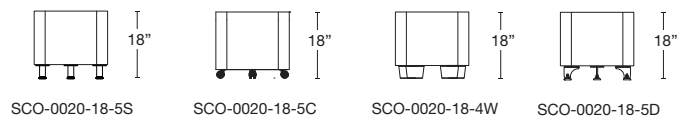
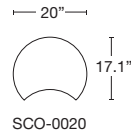
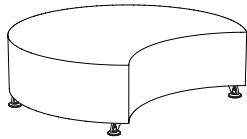

■ = Junior seat height 16"

PENTAGON OTTOMANS

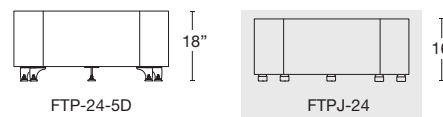
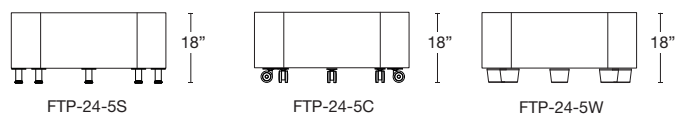
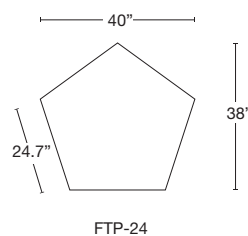
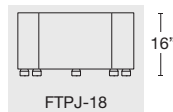
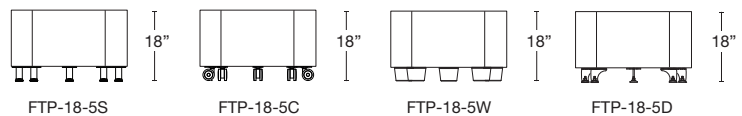
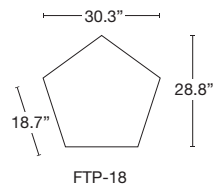
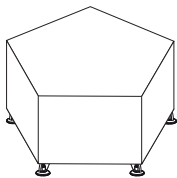

■ = Junior seat height 16"

• 231-861-2194 • www.mtcontract.com

CURVE OTTOMANS

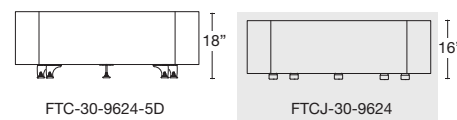
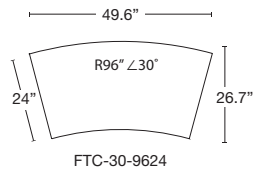
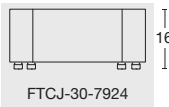
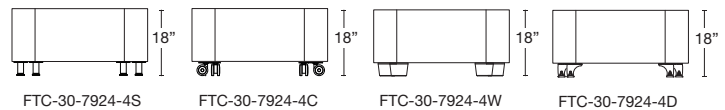
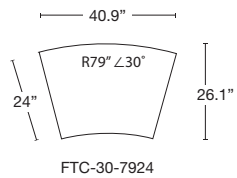
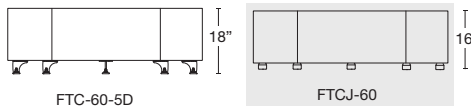
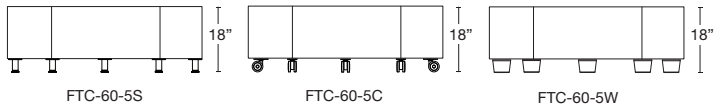
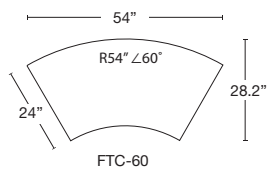
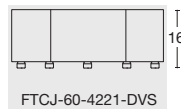
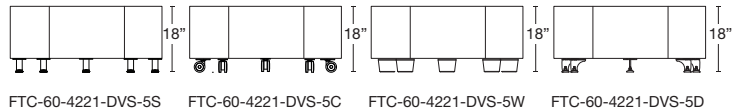
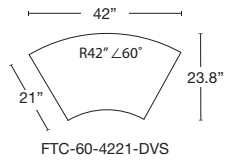
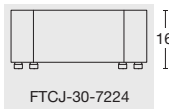
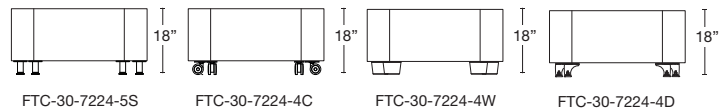
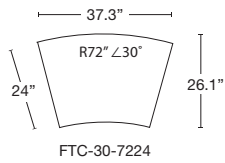
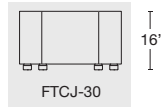
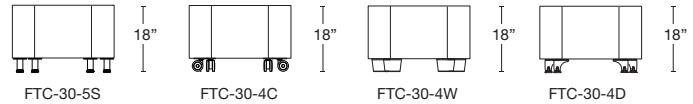
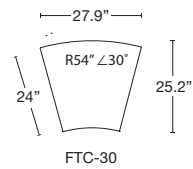
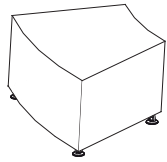

R = Radius in inches  
 ∠ = Curve Angle in degrees  
 ■ = Junior seat height 16"

SQUARE OTTOMANS

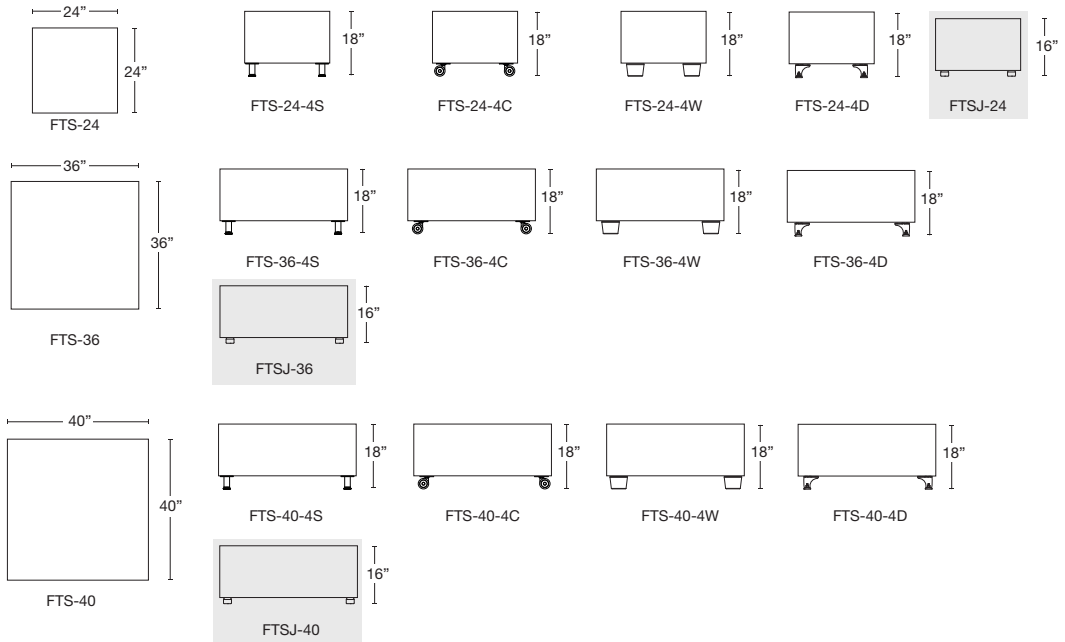
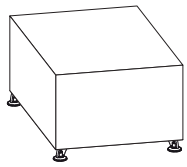

■ = Junior seat height 16"

RECTANGLE OTTOMANS

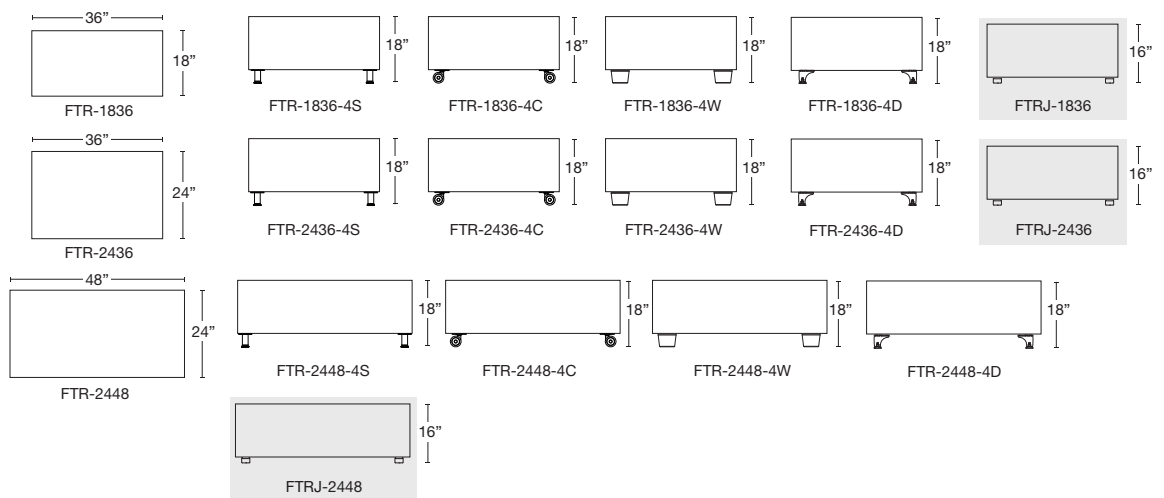
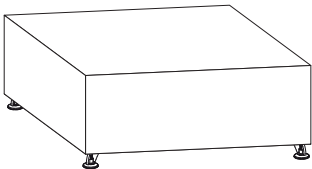

■ = Junior seat height 16"

GAME CONTROLLER OTTOMANS

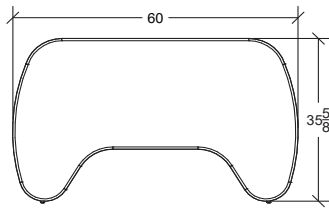

FTGC-3660-5S

FTGC-3660-5C

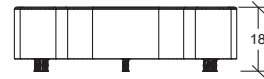
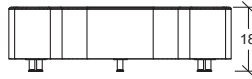

FTGC-3660-5W

FTGC-3660-5D

FTGCJ-3660

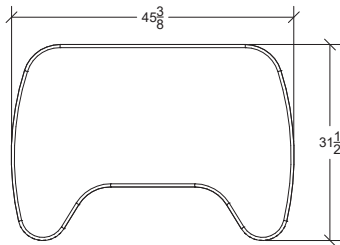
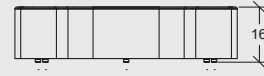
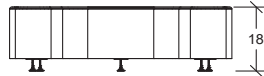
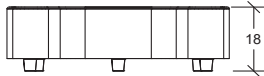

FTGC-3245-4S

FTGC-3245-4C

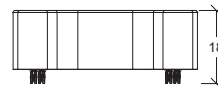
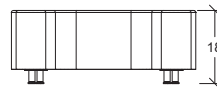

FTGC-3245-4W

FTGC-3245-4D

FTGCJ-3245

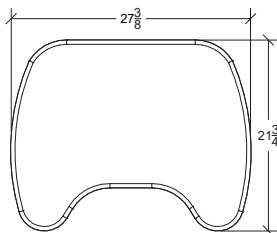
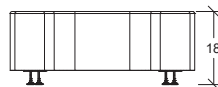
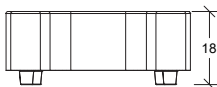

FTGC-2228-4S

FTGC-2228-4C

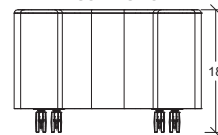
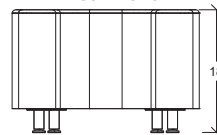

FTGC-2228-4W

FTGC-2228-4D

FTGCJ-2228

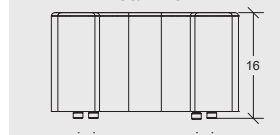
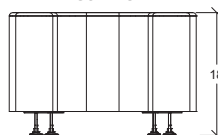
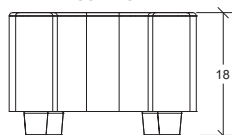

■ = Junior seat height 16"

• 231-861-2194 • www.mtcontract.com

HALFBACK SQUARE AND RECTANGLE OTTOMANS

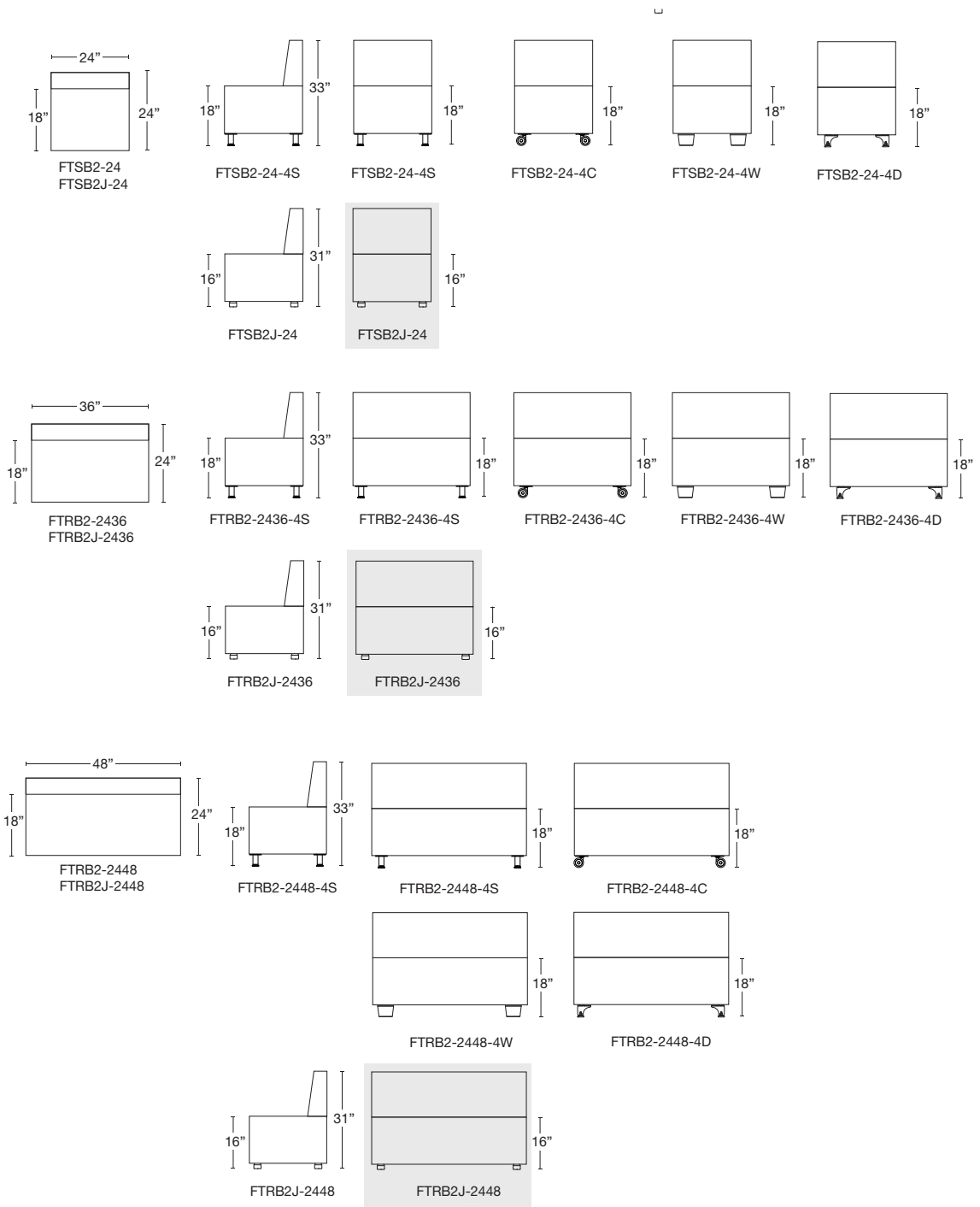
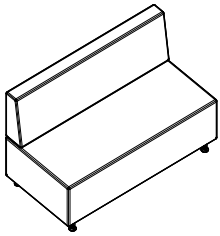

■ = Junior seat height 16"



HALFBACK SQUARE AND RECTANGLE OTTOMANS cont'd

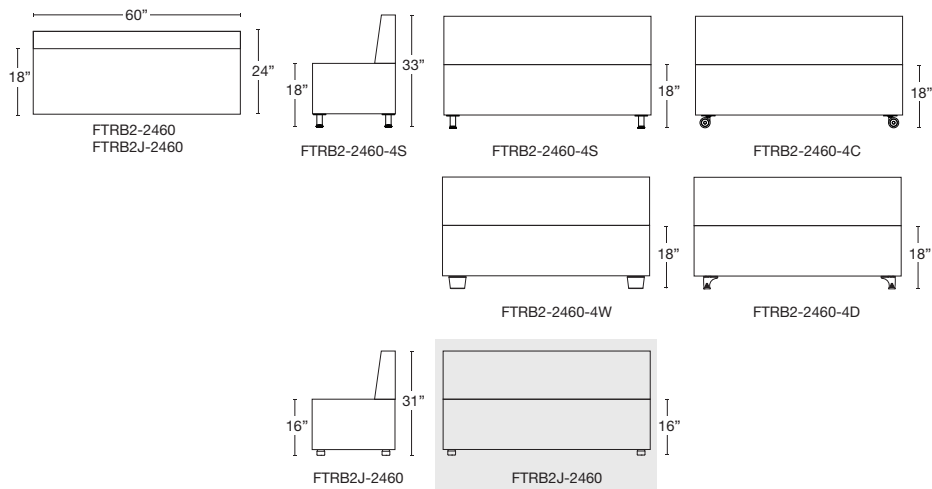
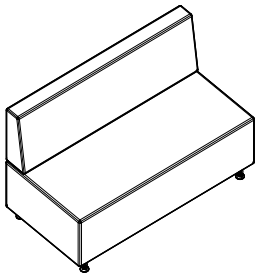

■ = Junior seat height 16"

HALFBACK CURVE OTTOMANS (Concave)

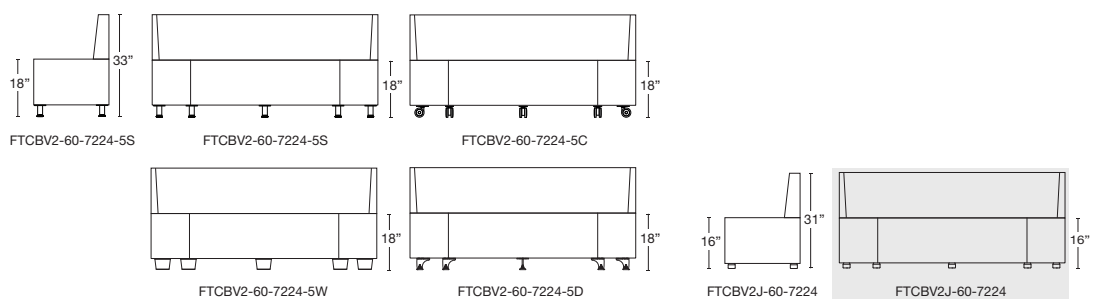
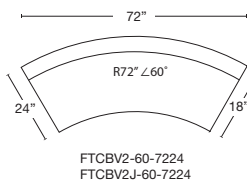
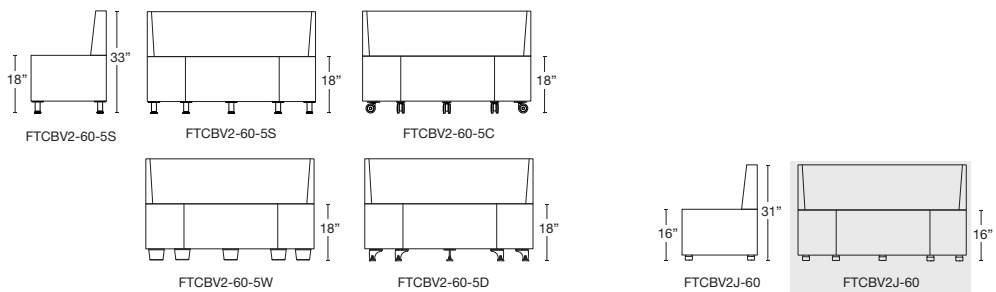
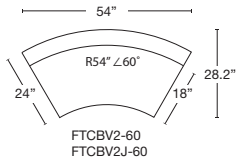
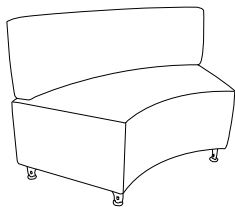

R = Radius in inches  
 ∠ = Curve Angle in degrees  
 ■ = Junior seat height 16"

HALFBACK CURVE OTTOMANS (Convex)

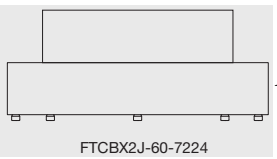
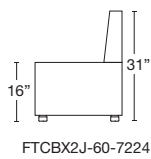
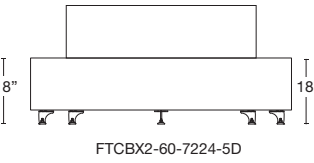
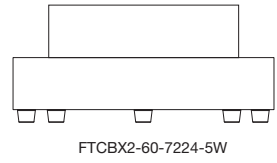
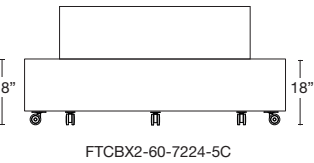
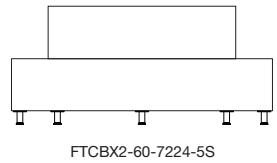
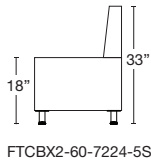
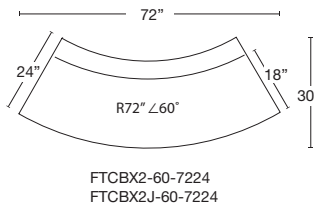
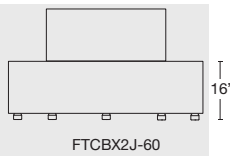
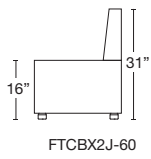
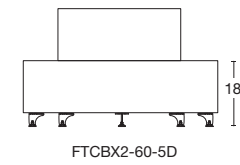
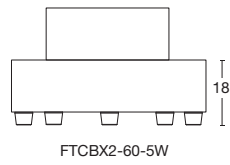
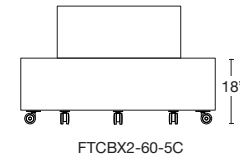
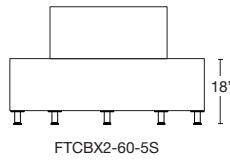
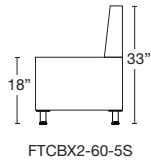
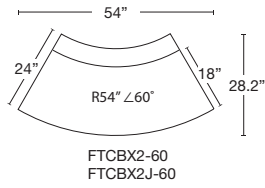
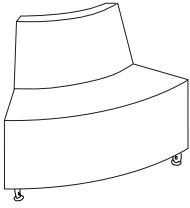

R = Radius in inches  
 ∠ = Curve Angle in degrees  
 ■ = Junior seat height 16"

QUARTER ROUND HALFBACK (Crescent)

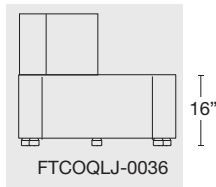
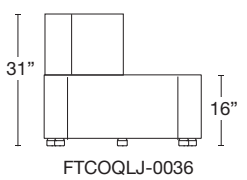
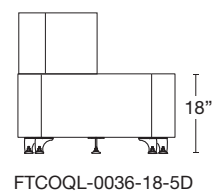
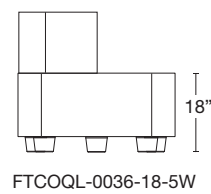
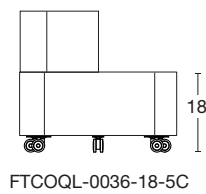
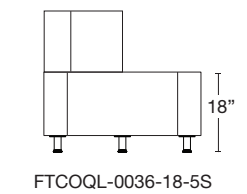
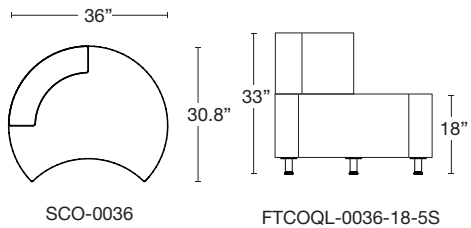
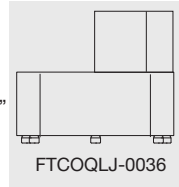
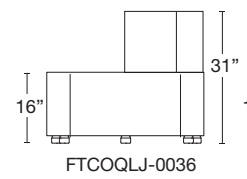
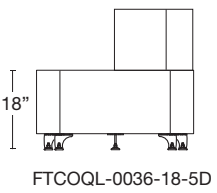
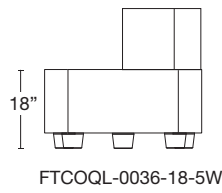
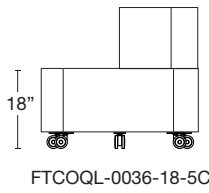
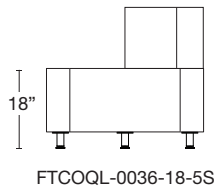
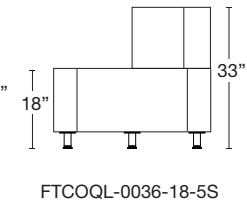
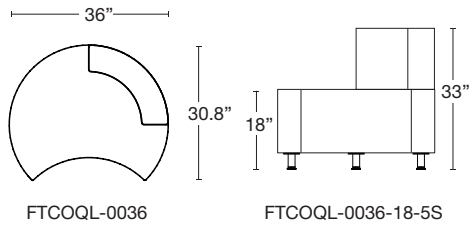
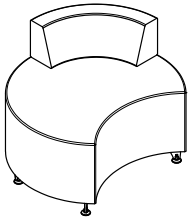

■ = Junior seat height 16"

ROUND OTTABLES

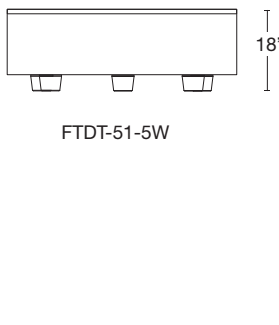
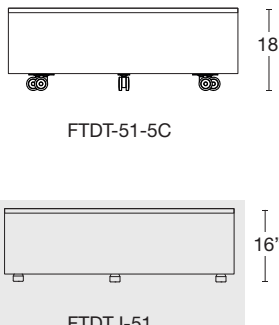
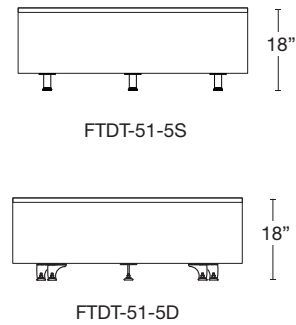
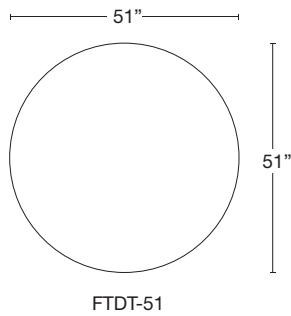
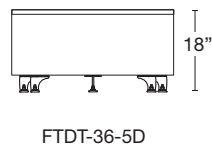
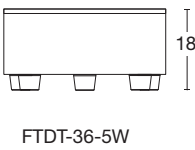
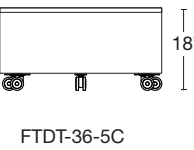
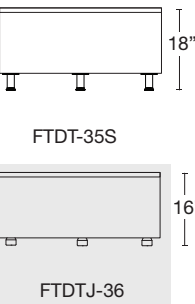
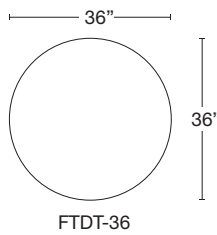
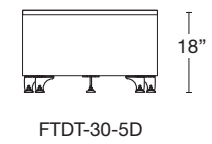
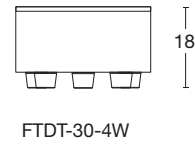
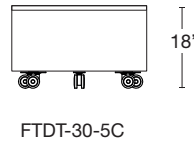
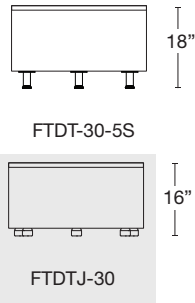
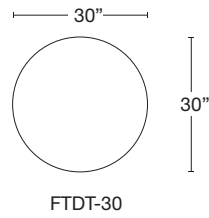
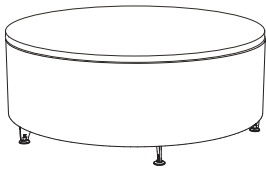

■ = Junior height 16"

RECTANGLE OTTABLES

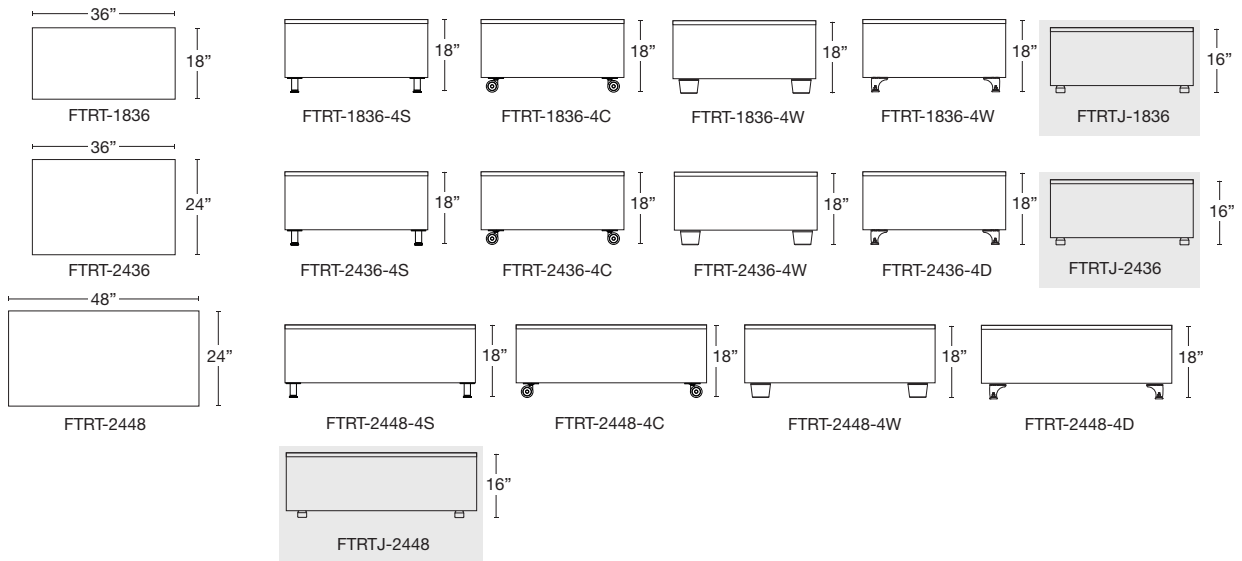
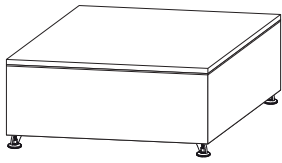

■ = Junior height 16"

SQUARE OTTABLES

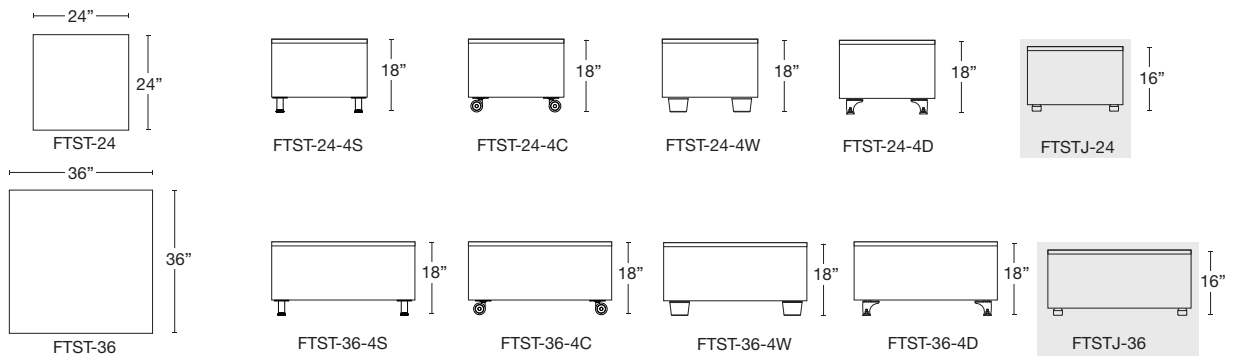
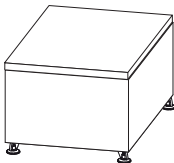

■ = Junior height 16"

## Crescents and Rounds

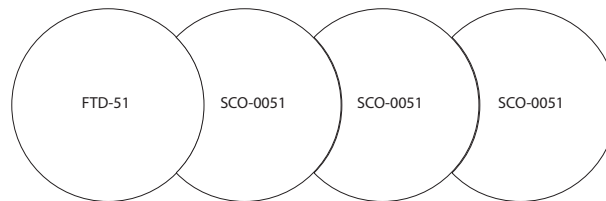
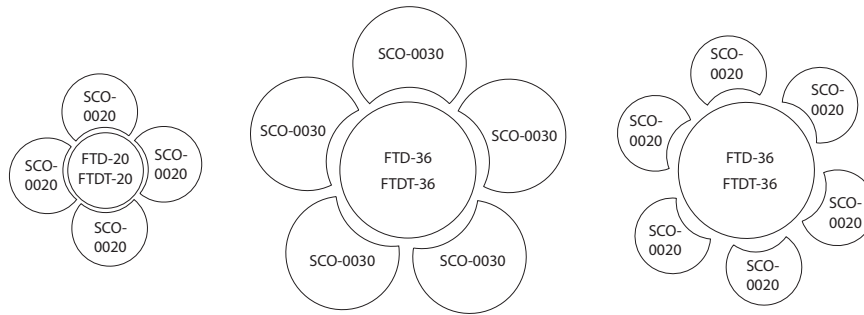

## Curves and Rounds

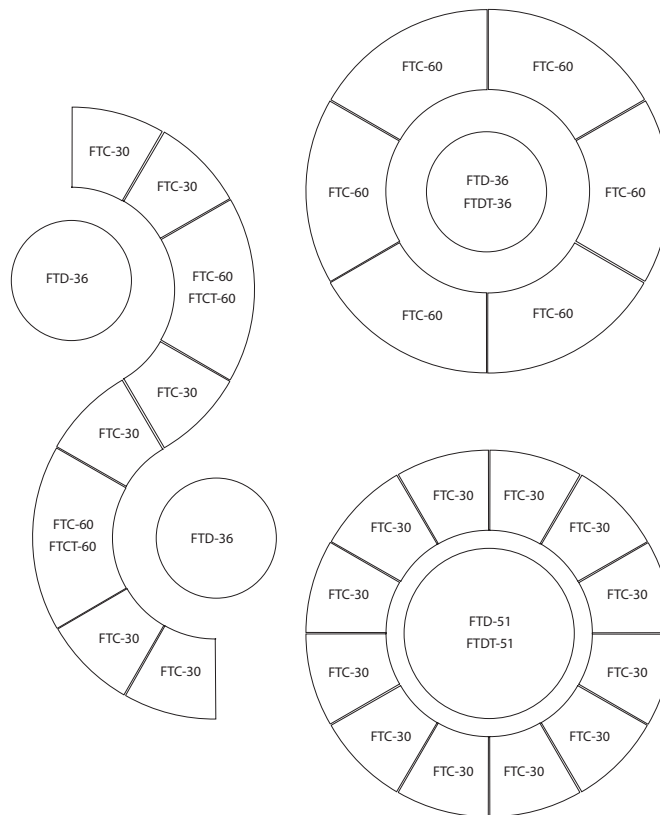

## Rectangles, Half-Rounds & Curves

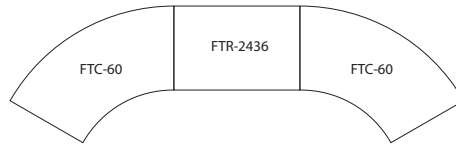
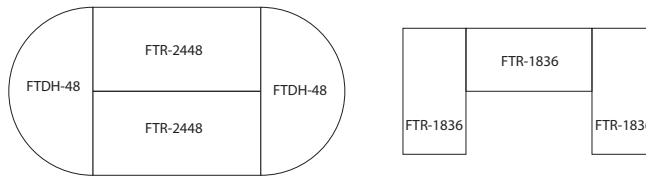

## Pentagons

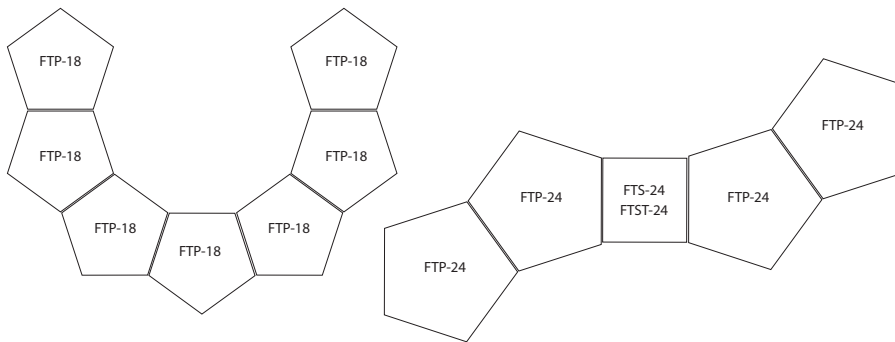

## Halfbacks, Ottomans & Ottables

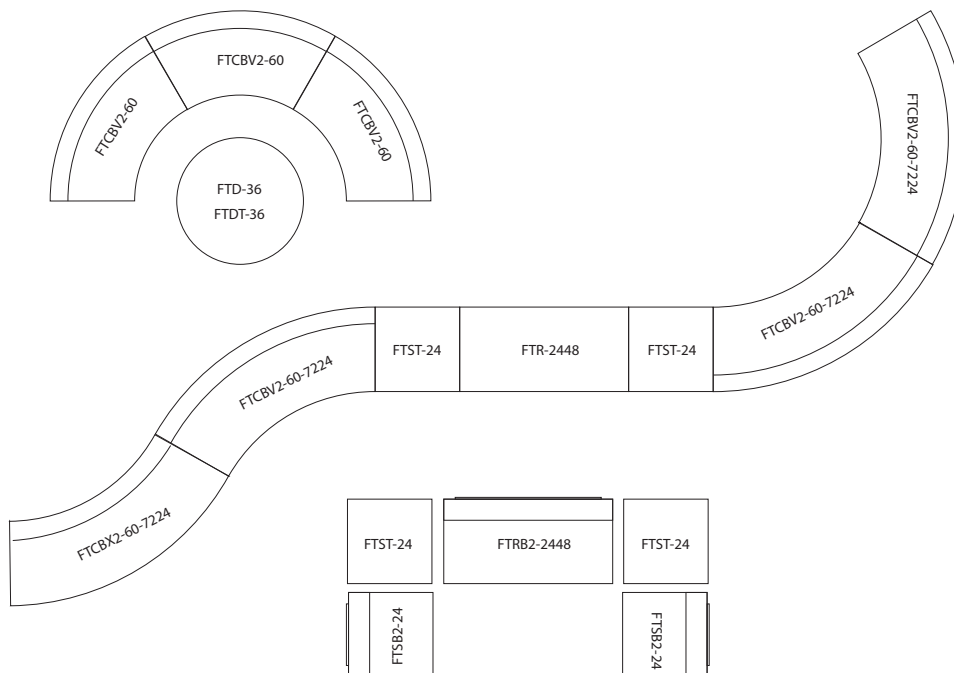

## General Specifications

<b>Seat:</b>	Fully upholstered seat. Interior construction consists of a 1" thick structural wood frame wrapped with ½" thick, 2.3# density foam on the sides. Seat basis is 2" of high density foam. Customer specifies upholstery fabric(s).
<b>Steel Legs:</b>	Steel post legs are fabricated from 5/16" powder coated plate steel and include a curved profile with a square mounting plate. The bottom of each leg is fitted with a threaded weld nut and 1-7/8" black leveling glide. Customer specifies powder coat color.
<b>Wood Legs:</b>	Wood legs are 3-1/3" x 3-1/2" hardwood with a 45 degree chamfer at the bottom edge. Wood post legs are attached 5/16"-18 bolt, washer and propeller nut. Wood legs can be finished in any of our standard wood (Oak, Maple or Sprayon) finishes. Customer specifies wood leg finish.
<b>Casters:</b>	Swivel casters are mounted to the base with a square mounting plate. FTD-20 and FTSC-20 models receive (5) 50mm casters, all other models receive (4) or (5) 75mm casters. Casters are black.
<b>Self Leveling Glides:</b> <i>Full Time Junior models</i>	Self-leveling glides are constructed of heavy duty steel, thermoplastic polyurethane and impact resistant nylon. Average installation height is 1-1/8". Glides are black.
<b>Seat Back:</b> <i>Full Time Halfbacks only</i>	Fully upholstered seat back. Seat back is 6" of high density foam at its base and tapers up to 3.5" of foam at the top. The seat back is built on a 1" thick rectangular wooden panel. Seat and seat back are joined by internal posts. Customer specifies upholstery fabric.
<b>Worksurface:</b> <i>Full Time Ottobles only</i>	Work surfaces are 1" thick, with a 7/8" particleboard core, .050" high-pressure laminate top and a .030 or thicker phenolic backer. Edge is 1/8" PVC. Worksurface shape matches the base shape. Customer specifies high pressure laminate work surface and PVC edgeband selections. *Connectivity option available in work surface.
<b>Fabric and Finishes</b>	
<b>Upholstery Choices:</b>	Visit the mediatechnologies website <a href="http://www.mediatechnologies.com/products/fabric/Seating">www.mediatechnologies.com/products/fabric/Seating</a> for graded fabric selection options.  Full Time Ottomans and Full Time Halfbacks offer the option of applying multiple fabrics. For multiple-fabric applications of different grades, average the grades of fabric and then add 1 grade. Next, round up for non-whole-number averages.  For example: Grade 3 and 4 would average 3.5. Add 1 grade (4.5) and round up to Grade 5 for pricing. Grades 3, 4 and 5 would average 4. Add 1 grade to get Grade 5 for pricing.
<b>Powder Coat Choices:</b>	Visit the mediatechnologies website <a href="http://www.mediatechnologies.com/resources/finishes/powder-coat-colors">www.mediatechnologies.com/resources/finishes/powder-coat-colors</a> .
<b>Wood Finish Choices:</b>	Visit each of the three wood finish pages on the mediatechnologies website <a href="http://www.mediatechnologies.com/resources/finishes/finishes-on-oak-standard">www.mediatechnologies.com/resources/finishes/finishes-on-oak-standard</a> .../finishes/finishes-on-maple-standard and .../finishes/sprayon.
<b>High Pressure Laminate Choices:</b>	Visit both laminate pages - <a href="http://www.mediatechnologies.com/resources/finishes/laminates">www.mediatechnologies.com/resources/finishes/laminates</a> and .../finishes/laminate-wood-grain.
<b>PVC Edgeband Choices:</b>	Visit the mediatechnologies website <a href="http://www.mediatechnologies.com/resources/finishes/pvc-edgebanding-colors-standard">www.mediatechnologies.com/resources/finishes/pvc-edgebanding-colors-standard</a> .



Electrical and Connectivity

**Connectivity for Full Time Ottoman & Full Time Halfback:**

Electrical and connectivity panels can only be mounted on Flat vertical surfaces of Full Time Ottomans and Full Time Halfbacks. The following shapes have at least one flat vertical surface where a panel can be mounted:

- Square
- Rectangle
- Pentagon
- Half Round
- Curve

**Connectivity Panel Option:**

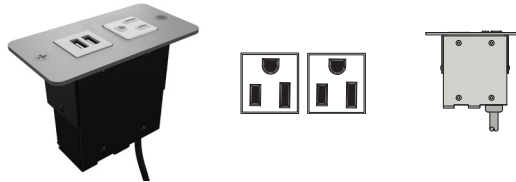

**DUET**

ADUF-1P2U-

- In-surface, rectangular panel, face mount, suitable for upholstery.
- 2" x 3.25" cutout
- 3.75" between mounting holes
- 1 AC receptacle and a Dual USB port (2 amps each)
- UL Listed
- 72" and 120" cord lengths
- White, silver and black face plates available
- Default orientaion of panel is horizontal

**Connectivity for Full Time Ottables:**

The **worksurface** of Full Time Ottables can accept any of the "In-Surface" -mount electrical and connectivity accessory devices shown in our "Connect" brochure ([www.mediatechnologies.com/resources/downloads/brochures](http://www.mediatechnologies.com/resources/downloads/brochures)). See the Connect brochure for descriptions, available options and cutout information. These devices include:

- |           |             |
|-----------|-------------|
| • Envoy   | • Powerspot |
| • Port    | • Ensemble  |
| • Aztech  | • Duet      |
| • Treo    | • Jolt      |
| • Dual Up | • Charge Up |



Only **Duet** (see above) connectivity panels can be mounted on **flat vertical** surfaces of Full Time Ottables. The following shapes have at least one flat vertical surface where a panel can be mounted:

- Square
- Rectangle

# Ottoman List Price

Round																	
Model Number	Base	Seat	Diameter (in.)	Seat Hgt. (in.)	Wgt. (lbs.)	COM Yd.										List Price	
							Grade 1 COM	Grade 2	Grade 3	Grade 4	Grade 5	Grade 6	Grade 7	Grade 8	Grade 9		
FTD-20-5S	Steel Post	Uph	20	18	64	1.5	\$1,129	\$1,212	\$1,302	\$1,385	\$1,406	\$1,425	\$1,490	\$1,529	\$1,586		
FTD-20-5C	Casters	Uph	20	18	64	1.5	\$1,000	\$1,085	\$1,173	\$1,256	\$1,277	\$1,296	\$1,316	\$1,393	\$1,445		
FTD-20-4W	Wood	Uph	20	18	64	1.5	\$1,000	\$1,085	\$1,173	\$1,256	\$1,277	\$1,296	\$1,316	\$1,393	\$1,445		
FTD-20-4D	Duo	Uph	20	18	64	1.5	\$1,000	\$1,085	\$1,173	\$1,256	\$1,277	\$1,296	\$1,316	\$1,393	\$1,445		
FTD-30-5S	Steel Post	Uph	30	18	84	2.5	\$1,455	\$1,617	\$1,765	\$1,913	\$2,064	\$2,210	\$2,357	\$2,520	\$2,697		
FTD-30-5C	Casters	Uph	30	18	84	2.5	\$1,455	\$1,617	\$1,765	\$1,913	\$2,064	\$2,210	\$2,357	\$2,520	\$2,697		
FTD-30-5W	Wood	Uph	30	18	84	2.5	\$1,455	\$1,617	\$1,765	\$1,913	\$2,064	\$2,210	\$2,357	\$2,520	\$2,697		
FTD-30-5D	Duo	Uph	30	18	84	2.5	\$1,455	\$1,617	\$1,765	\$1,913	\$2,064	\$2,210	\$2,357	\$2,520	\$2,697		
FTD-36-5S	Steel Post	Uph	36	18	96	2.5	\$1,613	\$1,796	\$1,960	\$2,124	\$2,290	\$2,453	\$2,620	\$2,636	\$2,732		
FTD-36-5C	Casters	Uph	36	18	96	2.5	\$1,613	\$1,796	\$1,960	\$2,124	\$2,290	\$2,453	\$2,620	\$2,636	\$2,732		
FTD-36-5W	Wood	Uph	36	18	96	2.5	\$1,613	\$1,796	\$1,960	\$2,124	\$2,290	\$2,453	\$2,620	\$2,636	\$2,732		
FTD-36-5D	Duo	Uph	36	18	96	2.5	\$1,613	\$1,796	\$1,960	\$2,124	\$2,290	\$2,453	\$2,620	\$2,636	\$2,732		
FTD-51-5S	Steel Post	Uph	51	18	132	3.5	\$2,418	\$2,618	\$2,793	\$2,968	\$3,144	\$3,318	\$3,493	\$3,564	\$3,694		
FTD-51-5C	Casters	Uph	51	18	132	3.5	\$2,418	\$2,618	\$2,793	\$2,968	\$3,144	\$3,318	\$3,493	\$3,564	\$3,694		
FTD-51-5W	Wood	Uph	51	18	132	3.5	\$2,418	\$2,618	\$2,793	\$2,968	\$3,144	\$3,318	\$3,493	\$3,564	\$3,694		
FTD-51-5D	Duo	Uph	51	18	132	3.5	\$2,418	\$2,618	\$2,793	\$2,968	\$3,144	\$3,318	\$3,493	\$3,564	\$3,694		
Round Junior																	
FTDJ-20	Self-Leveling Glide	Uph	20	16	64	1.5	\$1,072	\$1,151	\$1,236	\$1,315	\$1,335	\$1,353	\$1,415	\$1,452	\$1,506		
FTDJ-30	Self-Leveling Glide	Uph	30	16	84	2.5	\$1,382	\$1,536	\$1,676	\$1,817	\$1,960	\$2,099	\$2,239	\$2,394	\$2,562		
FTDJ-36	Self-Leveling Glide	Uph	36	16	96	2.5	\$1,532	\$1,706	\$1,862	\$2,017	\$2,175	\$2,330	\$2,489	\$2,504	\$2,595		
FTDJ-51	Self-Leveling Glide	Uph	51	16	132	3.5	\$2,297	\$2,487	\$2,653	\$2,819	\$2,986	\$3,152	\$3,318	\$3,385	\$3,509		
Crescent																	
Model Number	Base	Seat	Diameter (in.)	Seat Hgt. (in.)	Wgt. (lbs.)	COM Yd.										List Price	
							Grade 1 COM	Grade 2	Grade 3	Grade 4	Grade 5	Grade 6	Grade 7	Grade 8	Grade 9		
SCO-0020-18-5S	Steel Post	Uph	20	18	60	1.5	\$1,000	\$1,129	\$1,256	\$1,411	\$1,587	\$1,783	\$1,848	\$1,914	\$1,986		
SCO-0020-18-5C	Casters	Uph	20	18	60	1.5	\$1,000	\$1,129	\$1,256	\$1,411	\$1,587	\$1,783	\$1,848	\$1,914	\$1,986		
SCO-0020-18-5W	Wood	Uph	20	18	60	1.5	\$1,000	\$1,129	\$1,256	\$1,411	\$1,587	\$1,783	\$1,848	\$1,914	\$1,986		
SCO-0020-18-5D	Duo	Uph	20	18	60	1.5	\$1,000	\$1,129	\$1,256	\$1,411	\$1,587	\$1,783	\$1,848	\$1,914	\$1,986		
SCO-0030-18-5S	Steel Post	Uph	30	18	90	2.5	\$1,733	\$1,873	\$1,999	\$2,124	\$2,236	\$2,355	\$2,416	\$2,531	\$2,623		
SCO-0030-18-5C	Casters	Uph	30	18	90	2.5	\$1,733	\$1,873	\$1,999	\$2,124	\$2,236	\$2,355	\$2,416	\$2,531	\$2,623		
SCO-0030-18-5W	Wood	Uph	30	18	90	2.5	\$1,733	\$1,873	\$1,999	\$2,124	\$2,236	\$2,355	\$2,416	\$2,531	\$2,623		
SCO-0030-18-5D	Duo	Uph	30	18	90	2.5	\$1,733	\$1,873	\$1,999	\$2,124	\$2,236	\$2,355	\$2,416	\$2,531	\$2,623		
SCO-0036-18-5S	Steel Post	Uph	36	18	108	2.5	\$1,926	\$2,053	\$2,255	\$2,384	\$2,574	\$2,708	\$2,807	\$2,910	\$3,014		
SCO-0036-18-5C	Casters	Uph	36	18	108	2.5	\$1,926	\$2,053	\$2,255	\$2,384	\$2,574	\$2,708	\$2,807	\$2,910	\$3,014		
SCO-0036-18-5W	Wood	Uph	36	18	108	2.5	\$1,926	\$2,053	\$2,255	\$2,384	\$2,574	\$2,708	\$2,807	\$2,910	\$3,014		
SCO-0036-18-5D	Duo	Uph	36	18	108	2.5	\$1,926	\$2,053	\$2,255	\$2,384	\$2,574	\$2,708	\$2,807	\$2,910	\$3,014		
SCO-0051-18-5S	Steel Post	Uph	51	18	121	3.5	\$2,418	\$2,618	\$2,793	\$2,968	\$3,144	\$3,318	\$3,439	\$3,564	\$3,694		
SCO-0051-18-5C	Casters	Uph	51	18	121	3.5	\$2,418	\$2,618	\$2,793	\$2,968	\$3,144	\$3,318	\$3,439	\$3,564	\$3,694		
SCO-0051-18-5W	Wood	Uph	51	18	121	3.5	\$2,418	\$2,618	\$2,793	\$2,968	\$3,144	\$3,318	\$3,439	\$3,564	\$3,694		
SCO-0051-18-5D	Duo	Uph	51	18	121	3.5	\$2,418	\$2,618	\$2,793	\$2,968	\$3,144	\$3,318	\$3,439	\$3,564	\$3,694		
Crescent Junior																	
FTCOJ-0020	Self-Leveling Glide	Uph	20	16	60	1.5	\$1,000	\$1,129	\$1,256	\$1,411	\$1,587	\$1,783	\$1,848	\$1,914	\$1,986		
FTCOJ-0030	Self-Leveling Glide	Uph	30	16	90	2.5	\$1,733	\$1,873	\$1,999	\$2,124	\$2,236	\$2,355	\$2,416	\$2,531	\$2,623		
FTCOJ-0036	Self-Leveling Glide	Uph	36	16	108	2.5	\$1,926	\$2,053	\$2,255	\$2,384	\$2,574	\$2,708	\$2,807	\$2,910	\$3,014		
FTCOJ-0051	Self-Leveling Glide	Uph	51	16	121	3.5	\$2,418	\$2,618	\$2,793	\$2,968	\$3,144	\$3,318	\$3,439	\$3,564	\$3,694		

P-TIMESERIES-230519



# Ottoman List Price

Half Round																		
Model Number	Base	Seat	Depth (in.)	Width (in.)	Seat Hgt. (in.)	Wgt. (lbs.)	COM Yd.										List Price	
								Grade 1 COM	Grade 2	Grade 3	Grade 4	Grade 5	Grade 6	Grade 7	Grade 8	Grade 9		
FTHD-48-4S	Steel Post	Uph	24	48"	18	66	2.5	\$2,416	\$2,518	\$2,625	\$2,734	\$2,848	\$2,967	\$3,076	\$3,189	\$3,303		
FTHD-48-4C	Casters	Uph	24	48"	18	66	2.5	\$2,416	\$2,518	\$2,625	\$2,734	\$2,848	\$2,967	\$3,076	\$3,189	\$3,303		
FTHD-48-4W	Wood	Uph	24	48"	18	66	2.5	\$2,416	\$2,518	\$2,625	\$2,734	\$2,848	\$2,967	\$3,076	\$3,189	\$3,303		
FTHD-48-4D	Duo	Uph	24	48"	18	66	2.5	\$2,416	\$2,518	\$2,625	\$2,734	\$2,848	\$2,967	\$3,076	\$3,189	\$3,303		
Half Round Junior																		
FTHDJ-48	Self-Leveling Glide	Uph	24	48"	16	66	2.5	\$2,416	\$2,518	\$2,625	\$2,734	\$2,848	\$2,967	\$3,076	\$3,189	\$3,303		
Curve																		
Model Number	Base	Seat	Return Depth (in.)	Width (in.)	Seat Hgt. (in.)	Wgt. (lbs.)	COM Yd.										List Price	
								Grade 1 COM	Grade 2	Grade 3	Grade 4	Grade 5	Grade 6	Grade 7	Grade 8	Grade 9		
FTC-30-4S	Steel Post	Uph	24	28	18	69	1.5	\$1,305	\$1,392	\$1,468	\$1,542	\$1,615	\$1,691	\$1,874	\$1,945	\$2,017		
FTC-30-4C	Casters	Uph	24	28	18	69	1.5	\$1,305	\$1,392	\$1,468	\$1,542	\$1,615	\$1,691	\$1,874	\$1,945	\$2,017		
FTC-30-4W	Wood	Uph	24	28	18	69	1.5	\$1,305	\$1,392	\$1,468	\$1,542	\$1,615	\$1,691	\$1,874	\$1,945	\$2,017		
FTC-30-4D	Duo	Uph	24	28	18	69	1.5	\$1,305	\$1,392	\$1,468	\$1,542	\$1,615	\$1,691	\$1,874	\$1,945	\$2,017		
FTC-60-4S	Steel Post	Uph	24	54	18	140	3	\$2,280	\$2,374	\$2,473	\$2,577	\$2,686	\$2,796	\$3,068	\$3,183	\$3,300		
FTC-60-5C	Casters	Uph	24	54	18	140	3	\$2,280	\$2,374	\$2,473	\$2,577	\$2,686	\$2,796	\$3,068	\$3,183	\$3,300		
FTC-60-5W	Wood	Uph	24	54	18	140	3	\$2,280	\$2,374	\$2,473	\$2,577	\$2,686	\$2,796	\$3,068	\$3,183	\$3,300		
FTC-60-5D	Duo	Uph	24	54	18	140	3	\$2,280	\$2,374	\$2,473	\$2,577	\$2,686	\$2,796	\$3,068	\$3,183	\$3,300		
FTC-30-7224-4S	Steel Post	Uph	24	37.25	18	84	2	\$1,638	\$1,708	\$1,853	\$1,931	\$2,010	\$2,095	\$2,183	\$2,251	\$2,333		
FTC-30-7224-4C	Casters	Uph	24	37.25	18	84	2	\$1,638	\$1,708	\$1,853	\$1,931	\$2,010	\$2,095	\$2,183	\$2,251	\$2,333		
FTC-30-7224-4W	Wood	Uph	24	37.25	18	84	2	\$1,638	\$1,708	\$1,853	\$1,931	\$2,010	\$2,095	\$2,183	\$2,251	\$2,333		
FTC-30-7224-4D	Duo	Uph	24	37.25	18	84	2	\$1,638	\$1,708	\$1,853	\$1,931	\$2,010	\$2,095	\$2,183	\$2,251	\$2,333		
FTC-60-4221-DVS-4S	Steel Post	Uph	21"	41.75"	18	85	2	\$1,563	\$1,627	\$1,694	\$1,764	\$1,839	\$1,916	\$1,997	\$2,071	\$2,145		
FTC-60-4221-DVS-5C	Casters	Uph	21"	41.75"	18	85	2	\$1,563	\$1,627	\$1,694	\$1,764	\$1,839	\$1,916	\$1,997	\$2,071	\$2,145		
FTC-60-4221-DVS-5W	Wood	Uph	21"	41.75"	18	85	2	\$1,563	\$1,627	\$1,694	\$1,764	\$1,839	\$1,916	\$1,997	\$2,071	\$2,145		
FTC-60-4221-DVS-5D	Duo	Uph	21"	41.75"	18	85	2	\$1,563	\$1,627	\$1,694	\$1,764	\$1,839	\$1,916	\$1,997	\$2,071	\$2,145		
Curve Junior																		
FTCJ-30	Self-Leveling Glide	Uph	24	28	16	69	1.5	\$1,305	\$1,392	\$1,468	\$1,542	\$1,615	\$1,691	\$1,874	\$1,945	\$2,017		
FTCJ-60	Self-Leveling Glide	Uph	24	54	16	140	3	\$2,280	\$2,374	\$2,473	\$2,577	\$2,686	\$2,796	\$3,068	\$3,183	\$3,300		
FTCJ-30-7224	Self-Leveling Glide	Uph	24	37.25	16	84	2	\$1,638	\$1,708	\$1,853	\$1,931	\$2,010	\$2,095	\$2,183	\$2,251	\$2,333		
FTCJ-60-4221-DVS	Self-Leveling Glide	Uph	21"	41.75"	16	85	2	\$1,563	\$1,627	\$1,694	\$1,764	\$1,839	\$1,916	\$1,997	\$2,071	\$2,145		
FTCJ-60-4221-18-DVS	Self-Leveling Glide	Uph	21"	41.75"	18	85	2	\$1,563	\$1,627	\$1,694	\$1,764	\$1,839	\$1,916	\$1,997	\$2,071	\$2,145		
Pentagon																		
Model Number	Base	Seat	Depth (in.)	Width (in.)	Seat Hgt. (in.)	Wgt. (lbs.)	COM Yd.										List Price	
								Grade 1 COM	Grade 2	Grade 3	Grade 4	Grade 5	Grade 6	Grade 7	Grade 8	Grade 9		
FTP-18-5S	Steel Post	Uph	28	30	18	63	1.75	\$1,570	\$1,670	\$1,757	\$1,847	\$1,934	\$2,025	\$2,097	\$2,175	\$2,255		
FTP-18-5C	Casters	Uph	28	30	18	63	1.75	\$1,570	\$1,670	\$1,757	\$1,847	\$1,934	\$2,025	\$2,097	\$2,175	\$2,255		
FTP-18-5W	Wood	Uph	28	30	18	63	1.75	\$1,570	\$1,670	\$1,757	\$1,847	\$1,934	\$2,025	\$2,097	\$2,175	\$2,255		
FTP-18-5D	Duo	Uph	28	30	18	63	1.75	\$1,570	\$1,670	\$1,757	\$1,847	\$1,934	\$2,025	\$2,097	\$2,175	\$2,255		
FTP-24-5S	Steel Post	Uph	37"	39"	18	84	2.5	\$1,804	\$1,945	\$2,071	\$2,197	\$2,322	\$2,449	\$2,537	\$2,630	\$2,726		
FTP-24-5C	Casters	Uph	37"	39"	18	84	2.5	\$1,804	\$1,945	\$2,071	\$2,197	\$2,322	\$2,449	\$2,537	\$2,630	\$2,726		
FTP-24-5W	Wood	Uph	37"	39"	18	84	2.5	\$1,804	\$1,945	\$2,071	\$2,197	\$2,322	\$2,449	\$2,537	\$2,630	\$2,726		
FTP-24-5D	Duo	Uph	37"	39"	18	84	2.5	\$1,804	\$1,945	\$2,071	\$2,197	\$2,322	\$2,449	\$2,537	\$2,630	\$2,726		
Pentagon Junior																		
FTPJ-18	Self-Leveling Glide	Uph	28	30	16	63	1.75	\$1,570	\$1,670	\$1,757	\$1,847	\$1,934	\$2,025	\$2,097	\$2,175	\$2,255		
FTPJ-24	Self-Leveling Glide	Uph	37"	39"	16	84	2.5	\$1,804	\$1,945	\$2,071	\$2,197	\$2,322	\$2,449	\$2,537	\$2,630	\$2,726		

P-TIMESERIES-230519



# Ottoman List Price

Square																	
Model Number	Base	Seat	Depth (in.)	Width (in.)	Seat Hgt. (in.)	Wgt. (lbs.)	COM Yd.									List Price	
								Grade 1 COM	Grade 2	Grade 3	Grade 4	Grade 5	Grade 6	Grade 7	Grade 8	Grade 9	
FTS-2424-4S	Steel Post	Uph	24	24	18	60	1.75	\$1,327	\$1,387	\$1,457	\$1,525	\$1,596	\$1,671	\$1,790	\$1,858	\$1,929	
FTS-2424-4C	Casters	Uph	24	24	18	60	1.75	\$1,327	\$1,387	\$1,457	\$1,525	\$1,596	\$1,671	\$1,790	\$1,858	\$1,929	
FTS-2424-4W	Wood	Uph	24	24	18	60	1.75	\$1,327	\$1,387	\$1,457	\$1,525	\$1,596	\$1,671	\$1,790	\$1,858	\$1,929	
FTS-2424-4D	Duo leg	Uph	24	24	18	60	1.75	\$1,327	\$1,387	\$1,457	\$1,525	\$1,596	\$1,671	\$1,790	\$1,858	\$1,929	
FTS-3636-4S	Steel Post	Uph	36	36	18	89	2.25	\$1,437	\$1,567	\$1,678	\$1,792	\$1,905	\$2,017	\$2,092	\$2,168	\$2,248	
FTS-3636-4C	Casters	Uph	36	36	18	89	2.25	\$1,437	\$1,567	\$1,678	\$1,792	\$1,905	\$2,017	\$2,092	\$2,168	\$2,248	
FTS-3636-4W	Wood	Uph	36	36	18	89	2.25	\$1,437	\$1,567	\$1,678	\$1,792	\$1,905	\$2,017	\$2,092	\$2,168	\$2,248	
FTS-3636-4D	Duo leg	Uph	36	36	18	89	2.25	\$1,437	\$1,567	\$1,678	\$1,792	\$1,905	\$2,017	\$2,092	\$2,168	\$2,248	
FTS-4040-4S	Steel post	uph	40	40	18	105	2.75	\$1,595	\$1,739	\$1,863	\$1,989	\$2,115	\$2,239	\$2,322	\$2,406	\$2,595	
FTS-4040-4C	Casters	uph	40	40	18	105	2.75	\$1,595	\$1,739	\$1,863	\$1,989	\$2,115	\$2,239	\$2,322	\$2,406	\$2,595	
FTS-4040-4W	Wood	uph	40	40	18	105	2.75	\$1,595	\$1,739	\$1,863	\$1,989	\$2,115	\$2,239	\$2,322	\$2,406	\$2,595	
FTS-4040-4D	Duo leg	uph	40	40	18	105	2.75	\$1,595	\$1,739	\$1,863	\$1,989	\$2,115	\$2,239	\$2,322	\$2,406	\$2,595	
Square Junior																	
FTSJ-2424	Self-Leveling Glide	Uph	24	24	16	60	1.75	\$1,327	\$1,387	\$1,457	\$1,525	\$1,596	\$1,671	\$1,790	\$1,858	\$1,929	
FTSJ-3636	Self-Leveling Glide	Uph	36	36	16	89	2.25	\$1,437	\$1,567	\$1,678	\$1,792	\$1,905	\$2,017	\$2,092	\$2,168	\$2,248	
FTSJ-4040	Self-Leveling Glide	Uph	40	40	16	105	2.75	\$1,595	\$1,739	\$1,863	\$1,989	\$2,115	\$2,239	\$2,322	\$2,406	\$2,595	
Rectangle																	
Model Number	Base	Seat	Depth (in.)	Width (in.)	Seat Hgt. (in.)	Wgt. (lbs.)	COM Yd.									List Price	
								Grade 1 COM	Grade 2	Grade 3	Grade 4	Grade 5	Grade 6	Grade 7	Grade 8	Grade 9	
FTR-1836-4S	Steel Post	Uph	18	36	18	55	1.75	\$1,325	\$1,386	\$1,456	\$1,544	\$1,629	\$1,717	\$1,806	\$1,847	\$1,913	
FTR-1836-4C	Casters	Uph	18	36	18	55	1.75	\$1,325	\$1,386	\$1,456	\$1,544	\$1,629	\$1,717	\$1,806	\$1,847	\$1,913	
FTR-1836-4W	Wood	Uph	18	36	18	55	1.75	\$1,325	\$1,386	\$1,456	\$1,544	\$1,629	\$1,717	\$1,806	\$1,847	\$1,913	
FTR-1836-4D	Duo	Uph	18	36	18	55	1.75	\$1,325	\$1,386	\$1,456	\$1,544	\$1,629	\$1,717	\$1,806	\$1,847	\$1,913	
FTR-2436-4S	Steel Post	Uph	24	36	18	72	1.75	\$1,357	\$1,425	\$1,512	\$1,600	\$1,717	\$1,779	\$1,856	\$1,916	\$1,982	
FTR-2436-4C	Casters	Uph	24	36	18	72	1.75	\$1,357	\$1,425	\$1,512	\$1,600	\$1,717	\$1,779	\$1,856	\$1,916	\$1,982	
FTR-2436-4W	Wood	Uph	24	36	18	72	1.75	\$1,357	\$1,425	\$1,512	\$1,600	\$1,717	\$1,779	\$1,856	\$1,916	\$1,982	
FTR-2436-4D	Duo	Uph	24	36	18	72	1.75	\$1,357	\$1,425	\$1,512	\$1,600	\$1,717	\$1,779	\$1,856	\$1,916	\$1,982	
FTR-2448-4S	Steel Post	Uph	24	48"	18	80	2	\$1,673	\$1,744	\$1,815	\$1,891	\$1,971	\$2,052	\$2,127	\$2,210	\$2,287	
FTR-2448-4C	Casters	Uph	24	48"	18	80	2	\$1,673	\$1,744	\$1,815	\$1,891	\$1,971	\$2,052	\$2,127	\$2,210	\$2,287	
FTR-2448-4W	Wood	Uph	24	48"	18	80	2	\$1,673	\$1,744	\$1,815	\$1,891	\$1,971	\$2,052	\$2,127	\$2,210	\$2,287	
FTR-2448-4D	Duo	Uph	24	48"	18	80	2	\$1,673	\$1,744	\$1,815	\$1,891	\$1,971	\$2,052	\$2,127	\$2,210	\$2,287	
Rectangle Junior																	
FTRJ-1836	Self-Leveling Glide	Uph	18	36	16	55	1.75	\$1,325	\$1,386	\$1,456	\$1,544	\$1,629	\$1,717	\$1,806	\$1,847	\$1,913	
FTRJ-2436	Self-Leveling Glide	Uph	24	36	16	72	1.75	\$1,357	\$1,425	\$1,512	\$1,600	\$1,717	\$1,779	\$1,856	\$1,916	\$1,982	
FTRJ-2448	Self-Leveling Glide	Uph	24	48"	16	80	2	\$1,673	\$1,744	\$1,815	\$1,891	\$1,971	\$2,052	\$2,127	\$2,210	\$2,287	

# Ottoman List Price

Game Controller																		
Model Number	Base	Seat	Depth (in.)	Width (in.)	Seat Hgt. (in.)	Wgt. (lbs.)	COM Yd.										List Price	
								Grade 1 COM	Grade 2	Grade 3	Grade 4	Grade 5	Grade 6	Grade 7	Grade 8	Grade 9		
FTGC-2228-4S	Steel Post	Uph	22	28	18	55	1.75	\$1,250	\$1,357	\$1,467	\$1,570	\$1,597	\$1,620	\$1,645	\$1,742	\$1,807		
FTGC-2228-4C	Casters	Uph	22	28	18	55	1.75	\$1,250	\$1,357	\$1,467	\$1,570	\$1,597	\$1,620	\$1,645	\$1,742	\$1,807		
FTGC-2228-4W	Wood	Uph	22	28	18	55	1.75	\$1,250	\$1,357	\$1,467	\$1,570	\$1,597	\$1,620	\$1,645	\$1,742	\$1,807		
FTGC-2228-4D	Duo	Uph	22	28	18	55	1.75	\$1,250	\$1,357	\$1,467	\$1,570	\$1,597	\$1,620	\$1,645	\$1,742	\$1,807		
FTGC-3245-4S	Steel Post	Uph	32	46	18	90	2.5	\$1,833	\$2,041	\$2,228	\$2,414	\$2,603	\$2,788	\$2,978	\$2,996	\$3,105		
FTGC-3245-4C	Casters	Uph	32	46	18	90	2.5	\$1,833	\$2,041	\$2,228	\$2,414	\$2,603	\$2,788	\$2,978	\$2,996	\$3,105		
FTGC-3245-4W	Wood	Uph	32	46	18	90	2.5	\$1,833	\$2,041	\$2,228	\$2,414	\$2,603	\$2,788	\$2,978	\$2,996	\$3,105		
FTGC-3245-4D	Duo	Uph	32	46	18	90	2.5	\$1,833	\$2,041	\$2,228	\$2,414	\$2,603	\$2,788	\$2,978	\$2,996	\$3,105		
FTGC-3660-5S	Steel Post	Uph	36	60	18	165	3	\$2,748	\$2,975	\$3,174	\$3,373	\$3,573	\$3,771	\$3,970	\$4,050	\$4,198		
FTGC-3660-5C	Casters	Uph	36	60	18	165	3	\$2,748	\$2,975	\$3,174	\$3,373	\$3,573	\$3,771	\$3,970	\$4,050	\$4,198		
FTGC-3660-5W	Wood	Uph	36	60	18	165	3	\$2,748	\$2,975	\$3,174	\$3,373	\$3,573	\$3,771	\$3,970	\$4,050	\$4,198		
FTGC-3660-5D	Duo	Uph	36	60	18	165	3	\$2,748	\$2,975	\$3,174	\$3,373	\$3,573	\$3,771	\$3,970	\$4,050	\$4,198		
Game Controller Junior																		
FTGCJ-2228	Self-Leveling Glide	Uph	22	28	16	55	1.75	\$1,250	\$1,357	\$1,467	\$1,570	\$1,597	\$1,620	\$1,645	\$1,742	\$1,807		
FTGCJ-3245	Self-Leveling Glide	Uph	32	46	16	90	2.5	\$1,833	\$2,041	\$2,228	\$2,414	\$2,603	\$2,788	\$2,978	\$2,996	\$3,105		
FTGCJ-3660	Self-Leveling Glide	Uph	36	60	16	165	3	\$2,748	\$2,975	\$3,174	\$3,373	\$3,573	\$3,771	\$3,970	\$4,050	\$4,198		

# Halfback & Halfback Curve List Price

Halfback Square																			
Model Number	Base	Seat & Back	Depth (in.)	Width (in.)	Seat Hgt. (in.)	Overall Height (in.)	Wgt. (lbs.)	COM Yd.										List Price	
									Grade 1 COM	Grade 2	Grade 3	Grade 4	Grade 5	Grade 6	Grade 7	Grade 8	Grade 9		
FTSB2-2424-4S	Steel Post	Uph	24	24	18	33	55	2.5	\$2,183	\$2,249	\$2,297	\$2,358	\$2,420	\$2,482	\$2,574	\$2,668	\$2,765		
FTSB2-2424-4C	Casters	Uph	24	24	18	33	55	2.5	\$2,183	\$2,249	\$2,297	\$2,358	\$2,420	\$2,482	\$2,574	\$2,668	\$2,765		
FTSB2-2424-4W	Wood	Uph	24	24	18	33	55	2.5	\$2,183	\$2,249	\$2,297	\$2,358	\$2,420	\$2,482	\$2,574	\$2,668	\$2,765		
FTSB2-2424-4D	Duo	Uph	24	24	18	33	55	2.5	\$2,183	\$2,249	\$2,297	\$2,358	\$2,420	\$2,482	\$2,574	\$2,668	\$2,765		
Halfback Square Junior																			
FTSB2J-2424	Self-leveling Glide	Uph	24	24	16	31	55	2.5	\$2,183	\$2,249	\$2,297	\$2,358	\$2,420	\$2,482	\$2,574	\$2,668	\$2,765		
Halfback Square Corner																			
Model Number	Base	Seat & Back	Depth (in.)	Width (in.)	Seat Hgt. (in.)	Overall Height (in.)	Wgt. (lbs.)	COM Yd.										List Price	
									Grade 1 COM	Grade 2	Grade 3	Grade 4	Grade 5	Grade 6	Grade 7	Grade 8	Grade 9		
FTSB2C-2424-4S	Steel post	Uph	24	24	18	33	65	3	\$2,425	\$2,498	\$2,552	\$2,620	\$2,689	\$2,757	\$2,860	\$2,964	\$3,072		
FTSB2C-2424-4C	Casters	Uph	24	24	18	33	65	3	\$2,425	\$2,498	\$2,552	\$2,620	\$2,689	\$2,757	\$2,860	\$2,964	\$3,072		
FTSB2C-2424-4W	Wood	Uph	24	24	18	33	65	3	\$2,425	\$2,498	\$2,552	\$2,620	\$2,689	\$2,757	\$2,860	\$2,964	\$3,072		
FTSB2C-2424-4D	Duo	Uph	24	24	18	33	65	3	\$2,425	\$2,498	\$2,552	\$2,620	\$2,689	\$2,757	\$2,860	\$2,964	\$3,072		
Halfback Square Corner Junior																			
FTSB2CJ-2424	Self-leveling glide	Uph	24	24	16	31	65	3	\$2,425	\$2,498	\$2,552	\$2,620	\$2,689	\$2,757	\$2,860	\$2,964	\$3,072		
Halfback Rectangle																			
Model Number	Base	Seat	Depth	Width	Seat Hgt.	Overall Height	Wgt. (lbs.)	COM Yd.										List Price	
									Grade 1 COM	Grade 2	Grade 3	Grade 4	Grade 5	Grade 6	Grade 7	Grade 8	Grade 9		
FTRB2-2436-4S	Steel Post	Uph	24	36	18	33	55	3.25	\$3,284	\$3,384	\$3,453	\$3,550	\$3,643	\$3,737	\$3,871	\$4,012	\$4,159		
FTRB2-2436-4C	Casters	Uph	24	36	18	33	55	3.25	\$3,284	\$3,384	\$3,453	\$3,550	\$3,643	\$3,737	\$3,871	\$4,012	\$4,159		
FTRB2-2436-4W	Wood	Uph	24	36	18	33	55	3.25	\$3,284	\$3,384	\$3,453	\$3,550	\$3,643	\$3,737	\$3,871	\$4,012	\$4,159		
FTRB2-2436-4D	Duo	Uph	24	36	18	33	55	3.25	\$3,284	\$3,384	\$3,453	\$3,550	\$3,643	\$3,737	\$3,871	\$4,012	\$4,159		
FTRB2-2448-4S	Steel Post	Uph	24	48	18	33	75	4	\$3,284	\$3,384	\$3,453	\$3,550	\$3,643	\$3,737	\$3,871	\$4,012	\$4,159		
FTRB2-2448-4C	Casters	Uph	24	48	18	33	75	4	\$3,284	\$3,384	\$3,453	\$3,550	\$3,643	\$3,737	\$3,871	\$4,012	\$4,159		
FTRB2-2448-4W	Wood	Uph	24	48	18	33	75	4	\$3,284	\$3,384	\$3,453	\$3,550	\$3,643	\$3,737	\$3,871	\$4,012	\$4,159		
FTRB2-2448-4D	Duo	Uph	24	48	18	33	75	4	\$3,284	\$3,384	\$3,453	\$3,550	\$3,643	\$3,737	\$3,871	\$4,012	\$4,159		
FTRB2-2460-4S	Steel Post	Uph	24	60	18	33	100	5	\$3,329	\$3,486	\$3,649	\$3,820	\$4,000	\$4,187	\$4,340	\$4,497	\$4,662		
FTRB2-2460-4C	Casters	Uph	24	60	18	33	100	5	\$3,329	\$3,486	\$3,649	\$3,820	\$4,000	\$4,187	\$4,340	\$4,497	\$4,662		
FTRB2-2460-4W	Wood	Uph	24	60	18	33	100	5	\$3,329	\$3,486	\$3,649	\$3,820	\$4,000	\$4,187	\$4,340	\$4,497	\$4,662		
FTRB2-2460-4D	Duo	Uph	24	60	18	33	100	5	\$3,329	\$3,486	\$3,649	\$3,820	\$4,000	\$4,187	\$4,340	\$4,497	\$4,662		
Halfback Rectangle Junior																			
FTRB2J-2436	Self-leveling Glide	Uph	24	36	16	31	55	3.25	\$3,284	\$3,384	\$3,453	\$3,550	\$3,643	\$3,737	\$3,871	\$4,012	\$4,159		
FTRB2J-2448	Self-leveling Glide	Uph	24	48	16	31	75	4	\$3,284	\$3,384	\$3,453	\$3,550	\$3,643	\$3,737	\$3,871	\$4,012	\$4,159		
FTRB2J-2460	Self-leveling Glide	Uph	24	60	16	31	100	5	\$3,329	\$3,486	\$3,649	\$3,820	\$4,000	\$4,187	\$4,340	\$4,497	\$4,662		
Halfback 60-degree Curve (Seating on Concave side)																			
Model Number	Base	Seat	Curve	Over-all Width	Seat Hgt.	Overall Height	Wgt. (lbs.)	COM Yd.										List Price	
									Grade 1 COM	Grade 2	Grade 3	Grade 4	Grade 5	Grade 6	Grade 7	Grade 8	Grade 9		
FTCBV2-60-5S	Steel Post	Uph	60	54	18	33	160	5	\$3,995	\$4,250	\$4,542	\$4,815	\$5,103	\$5,406	\$5,605	\$5,807	\$6,018		
FTCBV2-60-5C	Casters	Uph	60	54	18	33	160	5	\$3,995	\$4,250	\$4,542	\$4,815	\$5,103	\$5,406	\$5,605	\$5,807	\$6,018		
FTCBV2-60-5W	Wood	Uph	60	54	18	33	160	5	\$3,995	\$4,250	\$4,542	\$4,815	\$5,103	\$5,406	\$5,605	\$5,807	\$6,018		
FTCBV2-60-5WD	Duo	Uph	60	54	18	33	160	5	\$3,995	\$4,250	\$4,542	\$4,815	\$5,103	\$5,406	\$5,605	\$5,807	\$6,018		
FTCBV2-60-7224-5S	Steel Post	Uph	60	72	18	33	180	5	\$4,196	\$4,463	\$4,770	\$5,056	\$5,353	\$5,678	\$5,885	\$6,098	\$6,322		
FTCBV2-60-7224-5C	Casters	Uph	60	72	18	33	180	5	\$4,196	\$4,463	\$4,770	\$5,056	\$5,353	\$5,678	\$5,885	\$6,098	\$6,322		
FTCBV2-60-7224-5W	Wood	Uph	60	72	18	33	180	5	\$4,196	\$4,463	\$4,770	\$5,056	\$5,353	\$5,678	\$5,885	\$6,098	\$6,322		
FTCBV2-60-7224-5D	Duo	Uph	60	72	18	33	180	5	\$4,196	\$4,463	\$4,770	\$5,056	\$5,353	\$5,678	\$5,885	\$6,098	\$6,322		

## Halfback Curve & Quarterback Crescent List Price

Halfback 60-degree Curve Junior Seating on Concave side)																	
FTCBV2J-60	Self-leveling Glide	Uph	60	54	16	31	160	5	\$3,995	\$4,250	\$4,542	\$4,815	\$5,103	\$5,406	\$5,605	\$5,807	\$6,018
FTCBV2J-60-7224	Self-leveling Glide	Uph	60	72	16	31	180	5	\$4,196	\$4,463	\$4,770	\$5,056	\$5,353	\$5,678	\$5,885	\$6,098	\$6,322

Halfback 60-degree Curve (Seating on Convex side)																			
Model Number	Base	Seat	Curve	Over-all Width	Seat Hgt.	Overall Height	Wgt. (lbs.)	COM Yd.										List Price	
									Grade 1 COM	Grade 2	Grade 3	Grade 4	Grade 5	Grade 6	Grade 7	Grade 8	Grade 9		
FTCBX2-60-5S	Steel Post	Uph	60	54	18	33	160	5	\$3,995	\$4,250	\$4,542	\$4,815	\$5,103	\$5,406	\$5,605	\$5,807	\$6,018		
FTCBX2-60-5C	Casters	Uph	60	54	18	33	160	5	\$3,995	\$4,250	\$4,542	\$4,815	\$5,103	\$5,406	\$5,605	\$5,807	\$6,018		
FTCBX2-60-5W	Wood	Uph	60	54	18	33	160	5	\$3,995	\$4,250	\$4,542	\$4,815	\$5,103	\$5,406	\$5,605	\$5,807	\$6,018		
FTCBX2-60-5D	Duo	Uph	60	54	18	33	160	5	\$3,995	\$4,250	\$4,542	\$4,815	\$5,103	\$5,406	\$5,605	\$5,807	\$6,018		
FTCBX2-60-7224-5S	Steel Post	Uph	60	72	18	33	180	5	\$4,196	\$4,463	\$4,770	\$5,056	\$5,353	\$5,678	\$5,885	\$6,098	\$6,322		
FTCBX2-60-7224-5C	Casters	Uph	60	72	18	33	180	5	\$4,196	\$4,463	\$4,770	\$5,056	\$5,353	\$5,678	\$5,885	\$6,098	\$6,322		
FTCBX2-60-7224-5W	Wood	Uph	60	72	18	33	180	5	\$4,196	\$4,463	\$4,770	\$5,056	\$5,353	\$5,678	\$5,885	\$6,098	\$6,322		
FTCBX2-60-7224-5D	Duo	Uph	60	72	18	33	180	5	\$4,196	\$4,463	\$4,770	\$5,056	\$5,353	\$5,678	\$5,885	\$6,098	\$6,322		

Halfback 60-degree Curve Junior (Seating on Convex side)																	
FTCBX2J-60	Self-leveling Glide	Uph	60	54	16	31	160	5	\$3,995	\$4,250	\$4,542	\$4,815	\$5,103	\$5,406	\$5,605	\$5,807	\$6,018
FTCBX2J-60-7224	Self-leveling Glide	Uph	60	72	16	31	180	5	\$4,196	\$4,463	\$4,770	\$5,056	\$5,353	\$5,678	\$5,885	\$6,098	\$6,322

Quarterback Crescent (Back on Left Side)																			
Model Number	Base	Seat & Back	Depth (in.)	Width (in.)	Seat Hgt. (in.)	Overall Height (in.)	Wgt. (lbs.)	COM Yd.										List Price	
									Grade 1 COM	Grade 2	Grade 3	Grade 4	Grade 5	Grade 6	Grade 7	Grade 8	Grade 9		
FTCOQL-0036-5S	Steel post	Uph	30	36	18	33	78	3.5	\$2,126	\$2,253	\$2,455	\$2,584	\$2,802	\$2,990	\$3,056	\$3,117	\$3,250		
FTCOQL-0036-5C	Casters	Uph	30	36	18	33	78	3.5	\$2,126	\$2,253	\$2,455	\$2,584	\$2,802	\$2,990	\$3,056	\$3,117	\$3,250		
FTCOQL-0036-5W	Wood	Uph	30	36	18	33	78	3.5	\$2,126	\$2,253	\$2,455	\$2,584	\$2,802	\$2,990	\$3,056	\$3,117	\$3,250		
FTCOQL-0036-5D	Duo	Uph	30	36	18	33	78	3.5	\$2,126	\$2,253	\$2,455	\$2,584	\$2,802	\$2,990	\$3,056	\$3,117	\$3,250		

Quarterback Crescent Junior (Back on Left Side)																	
FTCOQLJ-0036	Self-leveling glide	Uph	30	36	18	31	78	3.5	\$2,126	\$2,253	\$2,455	\$2,584	\$2,802	\$2,990	\$3,056	\$3,117	\$3,250

Quarterback Crescent (Back on Right Side)																			
Model Number	Base	Seat & Back	Depth (in.)	Width (in.)	Seat Hgt. (in.)	Overall Height (in.)	Wgt. (lbs.)	COM Yd.										List Price	
									Grade 1 COM	Grade 2	Grade 3	Grade 4	Grade 5	Grade 6	Grade 7	Grade 8	Grade 9		
FTCOQR-0036-5S	Steel post	Uph	30	36	18	33	78	3.5	\$2,126	\$2,253	\$2,455	\$2,584	\$2,802	\$2,990	\$3,056	\$3,117	\$3,250		
FTCOQR-0036-5C	Casters	Uph	30	36	18	33	78	3.5	\$2,126	\$2,253	\$2,455	\$2,584	\$2,802	\$2,990	\$3,056	\$3,117	\$3,250		
FTCOQR-0036-5W	Wood	Uph	30	36	18	33	78	3.5	\$2,126	\$2,253	\$2,455	\$2,584	\$2,802	\$2,990	\$3,056	\$3,117	\$3,250		
FTCOQR-0036-5D	Duo	Uph	30	36	18	33	78	3.5	\$2,126	\$2,253	\$2,455	\$2,584	\$2,802	\$2,990	\$3,056	\$3,117	\$3,250		

Quarterback Crescent Junior (Back on Right Side)																	
FTCOQRJ-0036	Self-leveling glide	Uph	30	36	18	31	78	3.5	\$2,126	\$2,253	\$2,455	\$2,584	\$2,802	\$2,990	\$3,056	\$3,117	\$3,250

# Ottables List Price

Round Ottables																
Model Number	Legs	Base	Worksur- face	Diameter (in.)	Height (in.)	Weight (in.)	COM (yds.)									List Price
								Grade 1 COM	Grade 2	Grade 3	Grade 4	Grade 5	Grade 6	Grade 7	Grade 8	
FTDT-30-5S	Steel Post	Uph	HPL	30	18	118	3	\$1,716	\$1,865	\$1,997	\$2,131	\$2,265	\$2,398	\$2,540	\$2,691	\$2,853
FTDT-30-5C	Casters	Uph	HPL	30	18	118	3	\$1,716	\$1,865	\$1,997	\$2,131	\$2,265	\$2,398	\$2,540	\$2,691	\$2,853
FTDT-30-5W	Wood Post	Uph	HPL	30	18	118	3	\$1,716	\$1,865	\$1,997	\$2,131	\$2,265	\$2,398	\$2,540	\$2,691	\$2,853
FTDT-30-5D	Duo	Uph	HPL	30	18	118	3	\$1,716	\$1,865	\$1,997	\$2,131	\$2,265	\$2,398	\$2,540	\$2,691	\$2,853
FTDT-36-5S	Steel Post	Uph	HPL	36	18	127	3.25	\$1,804	\$1,960	\$2,098	\$2,239	\$2,382	\$2,520	\$2,670	\$2,828	\$2,996
FTDT-36-5C	Casters	Uph	HPL	36	18	127	3.25	\$1,804	\$1,960	\$2,098	\$2,239	\$2,382	\$2,520	\$2,670	\$2,828	\$2,996
FTDT-36-5W	Wood Post	Uph	HPL	36	18	127	3.25	\$1,804	\$1,960	\$2,098	\$2,239	\$2,382	\$2,520	\$2,670	\$2,828	\$2,996
FTDT-36-5D	Duo	Uph	HPL	36	18	127	3.25	\$1,804	\$1,960	\$2,098	\$2,239	\$2,382	\$2,520	\$2,670	\$2,828	\$2,996
FTDT-51-5S	Steel Post	Uph	HPL	51	18	195	3.5	\$2,634	\$2,806	\$2,956	\$3,106	\$3,253	\$3,403	\$3,558	\$3,722	\$3,893
FTDT-51-5C	Casters	Uph	HPL	51	18	195	3.5	\$2,634	\$2,806	\$2,956	\$3,106	\$3,253	\$3,403	\$3,558	\$3,722	\$3,893
FTDT-51-5W	Wood Post	Uph	HPL	51	18	195	3.5	\$2,634	\$2,806	\$2,956	\$3,106	\$3,253	\$3,403	\$3,558	\$3,722	\$3,893
FTDT-51-5D	Duo	Uph	HPL	51	18	195	3.5	\$2,634	\$2,806	\$2,956	\$3,106	\$3,253	\$3,403	\$3,558	\$3,722	\$3,893

Round Junior Ottables																
FTDJ-30	Self-leveling Glides	Uph	HPL	30	16	118	3	\$1,716	\$1,865	\$1,997	\$2,131	\$2,265	\$2,398	\$2,540	\$2,691	\$2,853
FTDJ-36	Self-leveling Glides	Uph	HPL	36	16	127	3.25	\$1,804	\$1,960	\$2,098	\$2,239	\$2,382	\$2,520	\$2,670	\$2,828	\$2,996
FTDJ-51	Self-leveling Glides	Uph	HPL	51	16	195	3.5	\$2,634	\$2,806	\$2,956	\$3,106	\$3,253	\$3,403	\$3,558	\$3,722	\$3,893

Square Ottables																	
Model Number	Legs	Base	Worksur- face	Depth (in.)	Width (in.)	Height (in.)	Weight (in.)	COM (yds.)									List Price
									Grade 1 COM	Grade 2	Grade 3	Grade 4	Grade 5	Grade 6	Grade 7	Grade 8	
FTST-2424-4S	Steel Post	Uph	HPL	24	24	18	78	1.75	\$1,520	\$1,572	\$1,631	\$1,690	\$1,751	\$1,814	\$1,882	\$1,950	\$2,025
FTST-2424-4C	Casters	Uph	HPL	24	24	18	78	1.75	\$1,520	\$1,572	\$1,631	\$1,690	\$1,751	\$1,814	\$1,882	\$1,950	\$2,025
FTST-2424-4W	Wood Post	Uph	HPL	24	24	18	78	1.75	\$1,520	\$1,572	\$1,631	\$1,690	\$1,751	\$1,814	\$1,882	\$1,950	\$2,025
FTST-2424-4D	Duo	Uph	HPL	24	24	18	78	1.75	\$1,520	\$1,572	\$1,631	\$1,690	\$1,751	\$1,814	\$1,882	\$1,950	\$2,025
FTST-3636-4S	Steel Post	Uph	HPL	36	36	18	129	2.25	\$1,643	\$1,751	\$1,847	\$1,944	\$2,038	\$2,136	\$2,237	\$2,345	\$2,457
FTST-3636-4C	Casters	Uph	HPL	36	36	18	129	2.25	\$1,643	\$1,751	\$1,847	\$1,944	\$2,038	\$2,136	\$2,237	\$2,345	\$2,457
FTST-3636-4W	Wood Post	Uph	HPL	36	36	18	129	2.25	\$1,643	\$1,751	\$1,847	\$1,944	\$2,038	\$2,136	\$2,237	\$2,345	\$2,457
FTST-3636-4D	Duo	Uph	HPL	36	36	18	129	2.25	\$1,643	\$1,751	\$1,847	\$1,944	\$2,038	\$2,136	\$2,237	\$2,345	\$2,457
FTST-4040-4S	Steel Post	Uph	HPL	40	40	18	145	2.5	\$1,807	\$1,926	\$2,032	\$2,138	\$2,242	\$2,350	\$2,461	\$2,580	\$2,703
FTST-4040-4C	Casters	Uph	HPL	40	40	18	145	2.5	\$1,807	\$1,926	\$2,032	\$2,138	\$2,242	\$2,350	\$2,461	\$2,580	\$2,703
FTST-4040-4W	Wood Post	Uph	HPL	40	40	18	145	2.5	\$1,807	\$1,926	\$2,032	\$2,138	\$2,242	\$2,350	\$2,461	\$2,580	\$2,703
FTST-4040-4D	Duo	Uph	HPL	40	40	18	145	2.5	\$1,807	\$1,926	\$2,032	\$2,138	\$2,242	\$2,350	\$2,461	\$2,580	\$2,703

Square Junior Ottables																	
FTSTJ-2424	Self-leveling Glides	Uph	HPL	24	24	16	78	1.75	\$1,520	\$1,572	\$1,631	\$1,690	\$1,751	\$1,814	\$1,882	\$1,950	\$2,025
FTSTJ-3636	Self-leveling Glides	Uph	HPL	36	36	16	129	2.25	\$1,643	\$1,751	\$1,847	\$1,944	\$2,038	\$2,136	\$2,237	\$2,345	\$2,457
FTSTJ-4040	Self-leveling Glides	Uph	HPL	40	40	16	145	2.5	\$1,807	\$1,926	\$2,032	\$2,138	\$2,242	\$2,350	\$2,461	\$2,580	\$2,703



# Ottables List Price

Rectangle Ottables																		
Model Number	Legs	Base	Worksur- face	Depth (in.)	Width (in.)	Height (in.)	Weight (in.)	COM (yds.)										List Price
									Grade 1 COM	Grade 2	Grade 3	Grade 4	Grade 5	Grade 6	Grade 7	Grade 8	Grade 9	
FTRT-1824-4S	Steel Post	Uph	HPL	18	24	18	66	1.3	\$1,190	\$1,242	\$1,295	\$1,361	\$1,428	\$1,493	\$1,565	\$1,638	\$1,717	
FTRT-1824-4C	Casters	Uph	HPL	18	24	18	66	1.3	\$1,190	\$1,242	\$1,295	\$1,361	\$1,428	\$1,493	\$1,565	\$1,638	\$1,717	
FTRT-1824-4W	Wood Post	Uph	HPL	18	24	18	66	1.3	\$1,190	\$1,242	\$1,295	\$1,361	\$1,428	\$1,493	\$1,565	\$1,638	\$1,717	
FTRT-1824-4D	Duo	Uph	HPL	18	24	18	66	1.3	\$1,190	\$1,242	\$1,295	\$1,361	\$1,428	\$1,493	\$1,565	\$1,638	\$1,717	
FTRT-1836-4S	Steel Post	Uph	HPL	18	36	18	75	1.75	\$1,344	\$1,396	\$1,455	\$1,529	\$1,604	\$1,678	\$1,758	\$1,840	\$1,906	
FTRT-1836-4C	Casters	Uph	HPL	18	36	18	75	1.75	\$1,344	\$1,396	\$1,455	\$1,529	\$1,604	\$1,678	\$1,758	\$1,840	\$1,906	
FTRT-1836-4W	Wood Post	Uph	HPL	18	36	18	75	1.75	\$1,344	\$1,396	\$1,455	\$1,529	\$1,604	\$1,678	\$1,758	\$1,840	\$1,906	
FTRT-1836-4D	Duo	Uph	HPL	18	36	18	75	1.75	\$1,344	\$1,396	\$1,455	\$1,529	\$1,604	\$1,678	\$1,758	\$1,840	\$1,906	
FTRT-2436-4S	Steel Post	Uph	HPL	24	36	18	99	1.75	\$1,377	\$1,434	\$1,508	\$1,586	\$1,685	\$1,737	\$1,790	\$1,848	\$1,929	
FTRT-2436-4C	Casters	Uph	HPL	24	36	18	99	1.75	\$1,377	\$1,434	\$1,508	\$1,586	\$1,685	\$1,737	\$1,790	\$1,848	\$1,929	
FTRT-2436-4W	Wood Post	Uph	HPL	24	36	18	99	1.75	\$1,377	\$1,434	\$1,508	\$1,586	\$1,685	\$1,737	\$1,790	\$1,848	\$1,929	
FTRT-2436-4D	Duo	Uph	HPL	24	36	18	99	1.75	\$1,377	\$1,434	\$1,508	\$1,586	\$1,685	\$1,737	\$1,790	\$1,848	\$1,929	
FTRT-2448-4S	Steel Post	Uph	HPL	24	48	18	116	2	\$1,699	\$1,760	\$1,820	\$1,887	\$1,953	\$2,026	\$2,099	\$2,179	\$2,264	
FTRT-2448-4C	Casters	Uph	HPL	24	48	18	116	2	\$1,699	\$1,760	\$1,820	\$1,887	\$1,953	\$2,026	\$2,099	\$2,179	\$2,264	
FTRT-2448-4W	Wood Post	Uph	HPL	24	48	18	116	2	\$1,699	\$1,760	\$1,820	\$1,887	\$1,953	\$2,026	\$2,099	\$2,179	\$2,264	
FTRT-2448-4D	Duo	Uph	HPL	24	48	18	116	2	\$1,699	\$1,760	\$1,820	\$1,887	\$1,953	\$2,026	\$2,099	\$2,179	\$2,264	
Rectangle Junior Ottables																		
FTRTJ-1824	Self-leveling Glides	Uph	HPL	18	24	16	66	1.3	\$1,190	\$1,242	\$1,295	\$1,361	\$1,428	\$1,493	\$1,565	\$1,638	\$1,717	
FTRTJ-1836	Self-leveling Glides	Uph	HPL	18	36	16	75	1.75	\$1,344	\$1,396	\$1,455	\$1,529	\$1,604	\$1,678	\$1,758	\$1,840	\$1,929	
FTRTJ-2436	Self-leveling Glides	Uph	HPL	24	36	16	99	1.75	\$1,377	\$1,434	\$1,508	\$1,586	\$1,685	\$1,737	\$1,790	\$1,848	\$1,906	
FTRTJ-2448	Self-leveling Glides	Uph	HPL	24	48	16	116	2	\$1,699	\$1,760	\$1,820	\$1,887	\$1,953	\$2,026	\$2,099	\$2,179	\$2,264	